



WiFiLink-RX

User Manual-Ruby System v1.1

Catalogue

I.Product Overview	01
II.Firmware Support	02
III. WiFiLink-RX Specifications	03
IV. LED Status Indicators	04
V. Button Functions	05
5-way Button	05
Record Button	05
Flash Button	05
VI. Connecting to Air Unit	06
VII. System Flashing	08
A. Obtaining the System Image file	09
B. Flashing Software	09
C. Installing Driver	10
D. Flashing System Image File	10
VIII. Frequently Asked Questions	14
A. Adjusting WiFiLink-RX Frequency and Air Unit Power	14
B. Adjusting Air Unit Video Output via WiFiLink-RX	15
C. Setting HDMI Video Output on WiFiLink-RX	16
D. Exporting Internal Storage Video from WiFiLink-RX	17
IX. Notes and Precautions	18

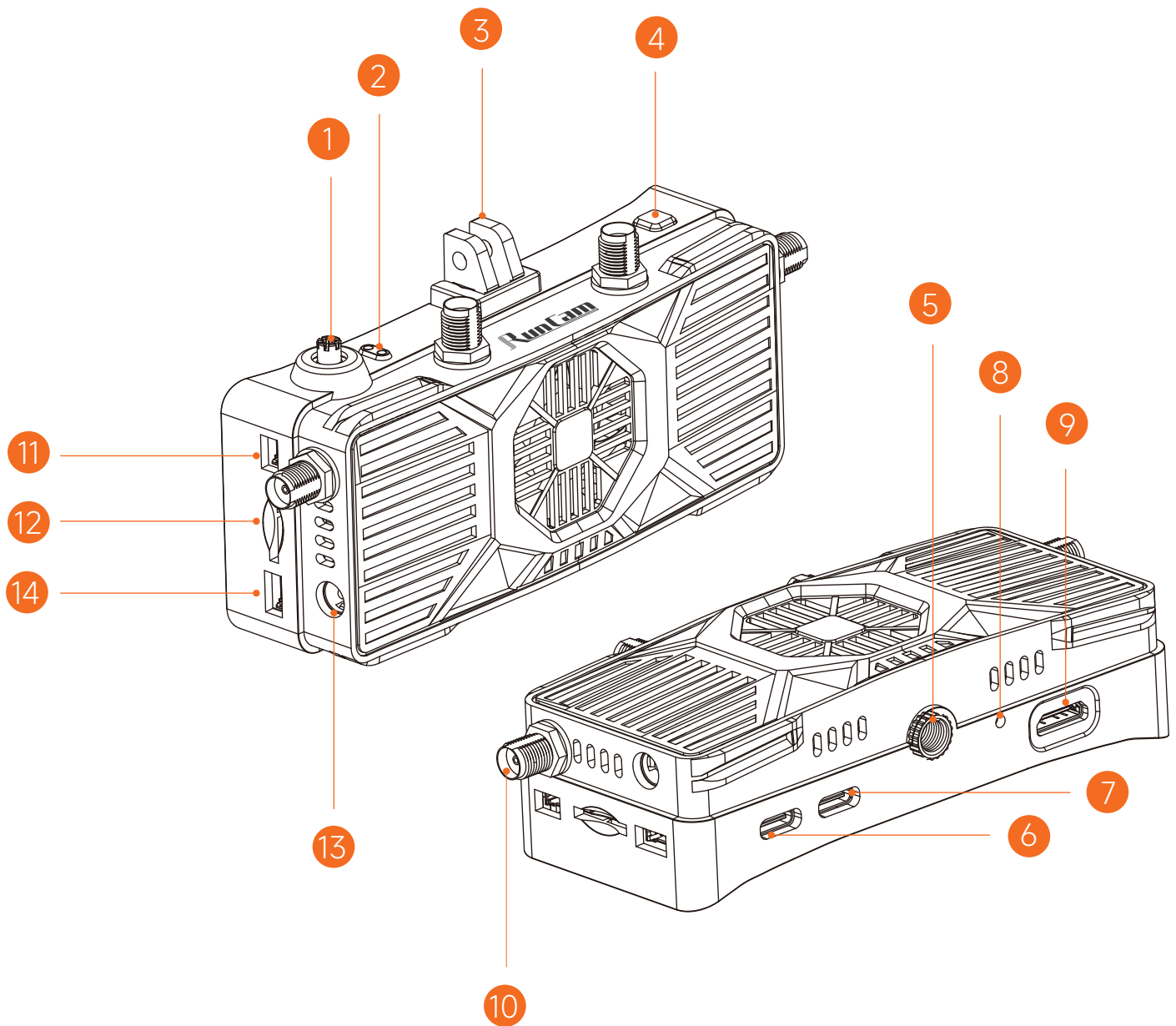

1. 5-way button

2. LED

3. Detachable mount

4. Record button

5. 1/4" threaded hole

6. OTG

7. Type-C

8. Flash button^[1]

9. Mini-HDMI

10. SMA(inner pin)

11. UART expansion

12. Micro-SD slot

13. DC power input^[2]

14. I2C expansion

[1]: Use a tool like SIM ejector pin or screwdriver to press.

[2]: Input power range: 9V ~ 30V.

Supports Ruby FPV or OpenIPC system. The default factory firmware is OpenIPC.

Ruby FPV Interface Overview



OpenIPC Interface Overview

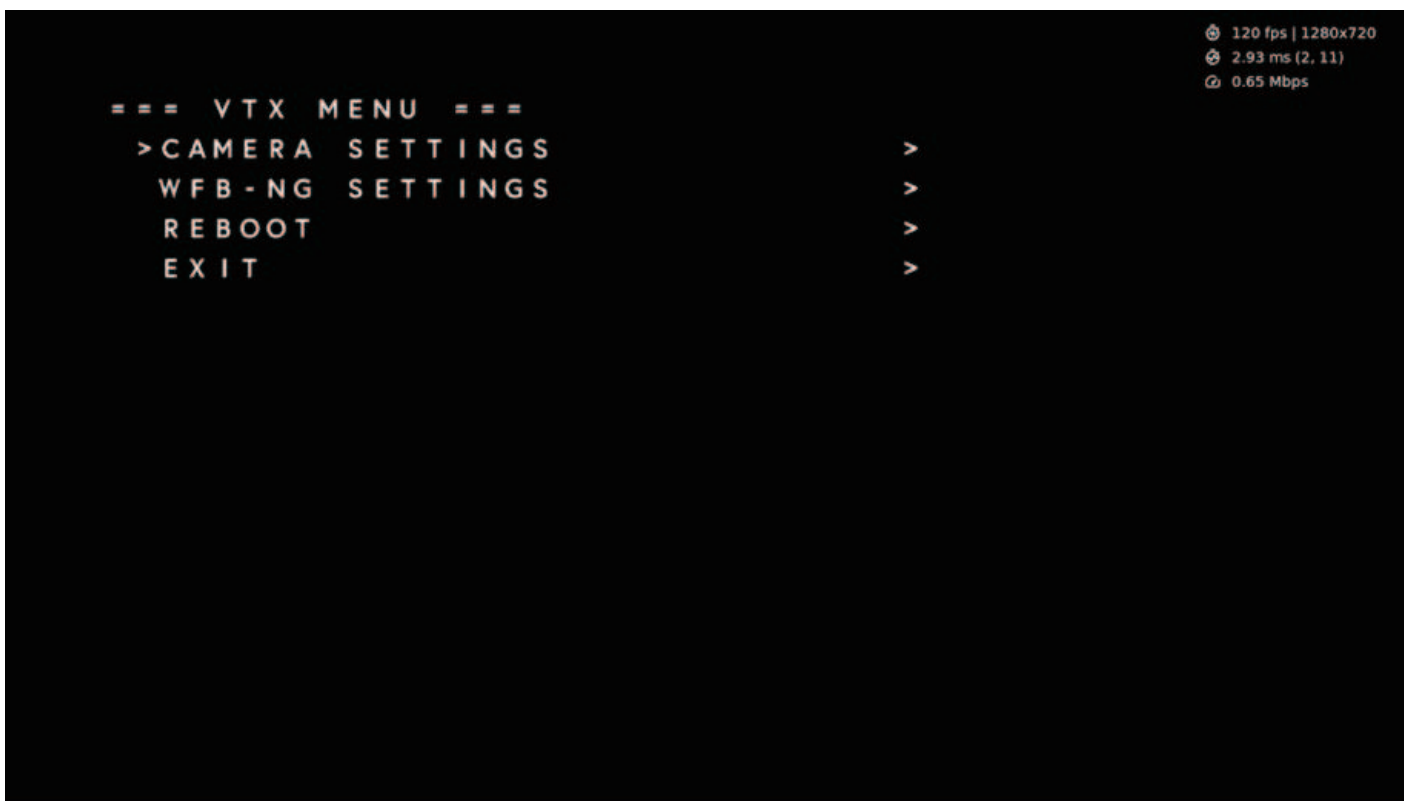

Model	WiFiLink-RX
Frequencies	5GHz
Transmission Power	<25dBm(FCC) <14dBm(CE) <20dBm(SRRC) <25dBm(MIC)
Interface	Mini-HDMI, Micro-SD, DC 5.5×2.1mm,Type-C
Mini-HDMI Output	1080P 60fps / 720P 60fps
Power Input	9~30V (3~6S)
MicroSD Card	Supports up to 256GB
Memory and Storage	1GB RAM + 32GB eMMC
System	Ruby FPV / OpenIPC
Dimensions	(L)110.0mm×(W)27.3mm×(H)46.0mm
Weight	122.0g (±1g) (antenna excluded)

Model	Stick Antennas
Polarization	Vertical Polarization (VP)
Frequencies	5150~5850 MHz
Average Gain	2.5dBi
Standing Wave Ratio (SWR)	≤2.0
Dimensions	(R)4.8mm×(H)108.4mm
Weight	6.6g

Model	Pagoda Antennas
Polarization	Left-Hand Circular Polarization (LHCP)
Frequencies	5500~5900 MHz
Average Gain	2.5dBi
Standing Wave Ratio (SWR)	<=2.0
Dimensions	(R)8.0mm×(H)23.9mm
Weight	4.4g

▶ IV. LED Status Indicators

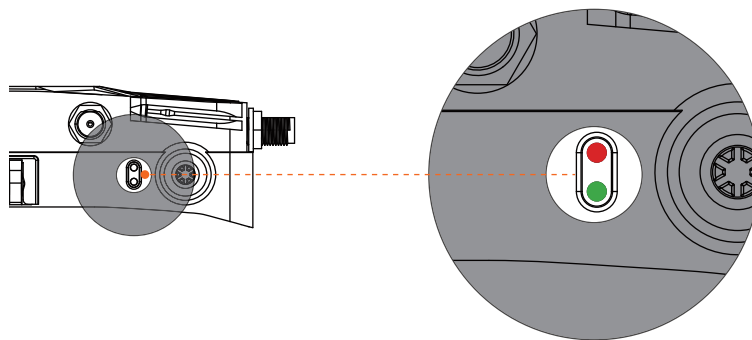

Green LED solid on: Wi-Fi is functioning normally

Green LED off: Wi-Fi malfunction

Red LED solid on: RX is powered

Red LED slow blinking: Recording in progress

Red LED fast blinking: Storage is full

Red and green LEDs blinking alternately: High temperature warning

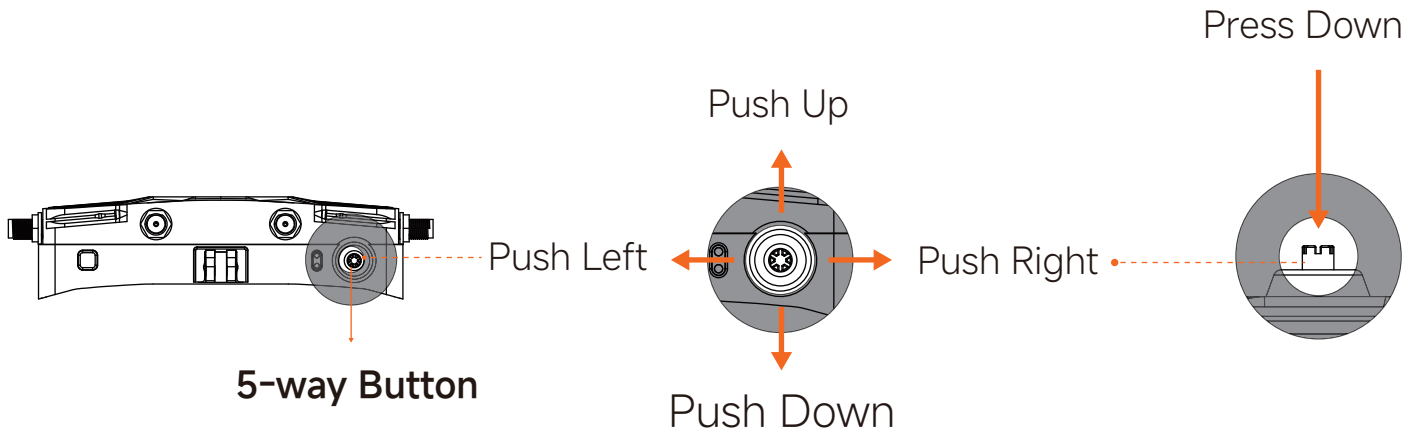

Ruby System: Push right to switch OSD interface. Press Down to confirm or open menu. Push up or down to navigate, and Push left to return to the previous menu.

OpenIPC System: Push up or down to change frequencies. Push right to adjust bandwidth (20MHz / 40MHz).

(Note: The above button functions are based on Ruby FPV V10.7 / OpenIPC V1.9.8. Button behavior may differ in future firmware versions. Please refer to the actual system for the most accurate information.)

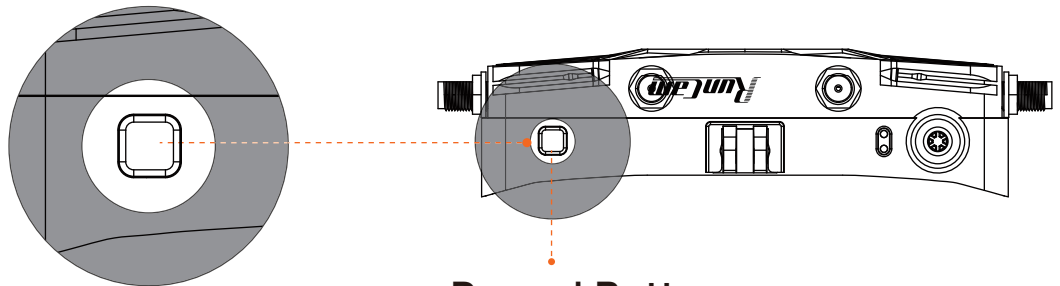

Record Button

Press to start or pause recording.

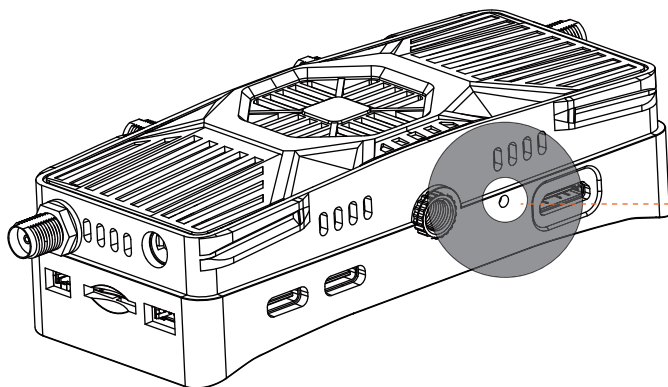

Flash Button

Press and hold the flash button, then connect DC power. After 2 seconds, release the button — the RX will enter flashing mode. At this point, connect the RX to a computer via Type-C, and begin the flashing process...

Demo Video URL

1. Install antennas for both WiFiLink 2 and WiFiLink-RX, then power both devices. Connect WiFiLink-RX to a display via HDMI cable.



2. After powering on devices, press down the 5-way button to open the menu, move to select Search → Start Search, press to confirm, and it will search the signal of the transmitter.

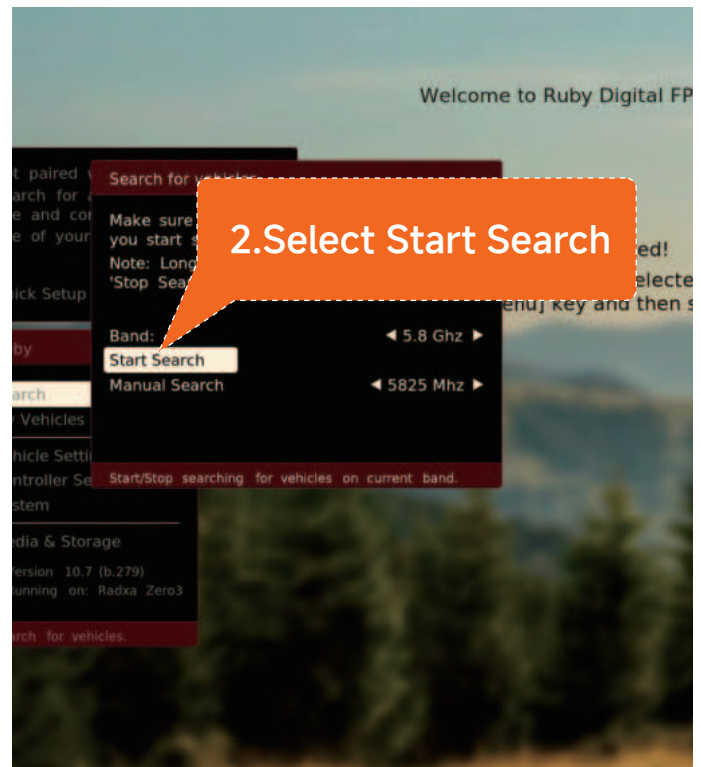
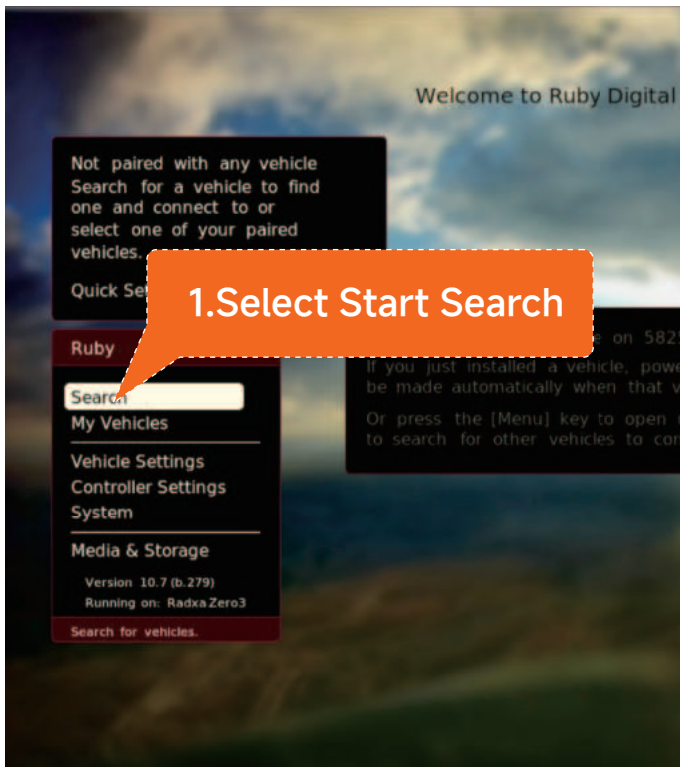

3. When finish the search, please choose “Connect for control”, confirm and connect.

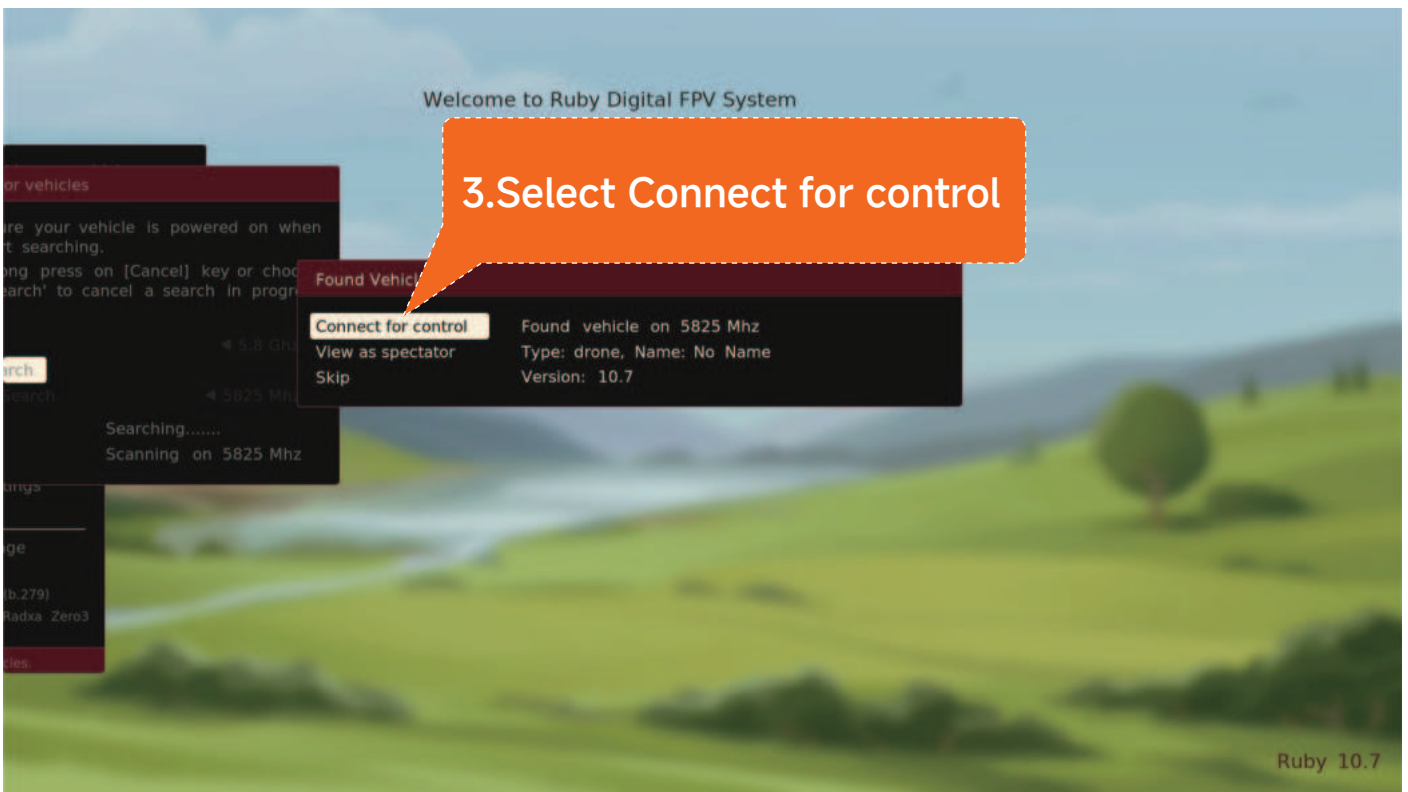

4. The feed from transmitter will be displayed when it connects successfully.



Note: Flashing the system will erase all files on the WiFiLink-RX's internal storage (eMMC) and TF card. Please back up important data in advance.

A. Obtaining the System Image file

1. Go to the Ruby FPV official website's Download page (<https://rubyfpv.com/downloads.php>), scroll down to find the latest system image files. Select the image file for RunCam VRx, and click to download.

(Note: The system version of the WiFiLink-RX must match the version on the air unit; otherwise, connection issues may occur.)

Version 10.8 (27 Mar 2025)

What's new:

- * Added support for Runcam VRx;
- * Updated Quick Setup menu;
- * Minor OSD updates;
- * Bug fixes;

Downloads:

Update for all hardware types:	ruby_update_10.8.zip
Pi Zero2, Pi 2,3,4 variants (full image):	ruby_image_pi_10.8.zip
RunCam, EMax VRx (full image):	ruby_image_radxa3ew_10.8.zip
Radxa 3E/3W (full image):	ruby_image_radxa3ew_10.8.zip
Radxa 3C (full image):	ruby_image_radxa3c_10.8.zip

2. Extract the downloaded compressed file to obtain a system image file.



ruby_image_radxa3ew_10.8.img



ruby_image_radxa3ew_10.8.zip

B. Flashing Software

1. Click the link below to download the compressed Driver&Tool compressed file.
 GoogleDrive:

<https://drive.google.com/drive/folders/1moljMrfbCeSgvW7LQA1RAOpFrKZshpGI?usp=sharing>

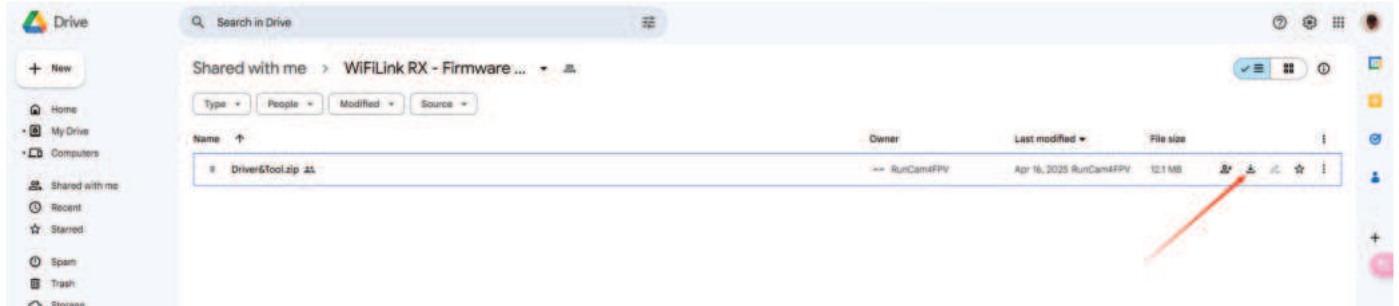

2. Extract the downloaded compressed file, to obtain flashing software and driver.

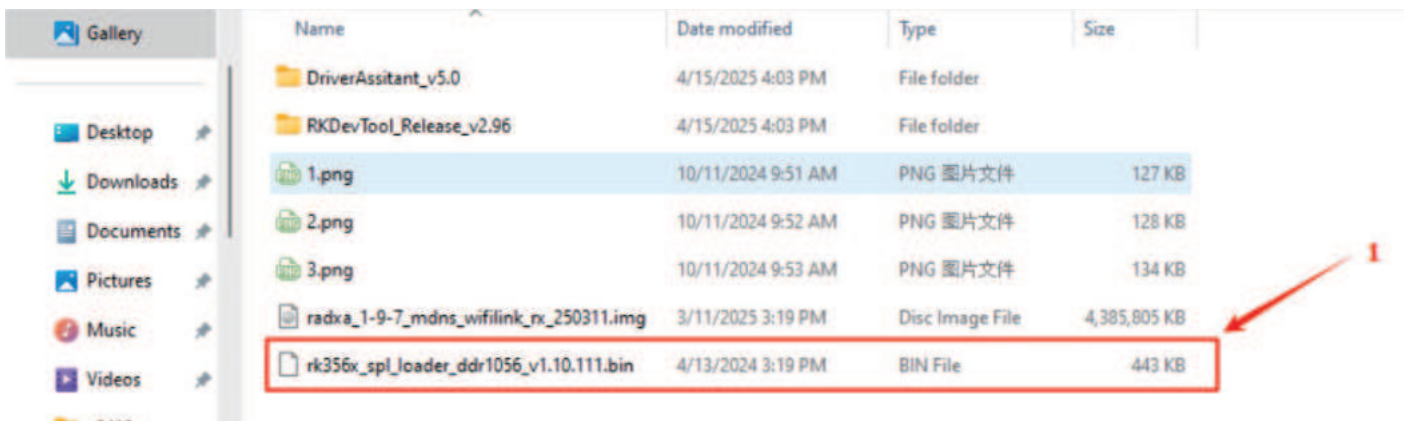

C. Installing Driver

1. Open DriverAssistant_v5.0 folder, find and double click DriverInstall.exe to execute it. Click Install to continue. It takes a few seconds to finish.

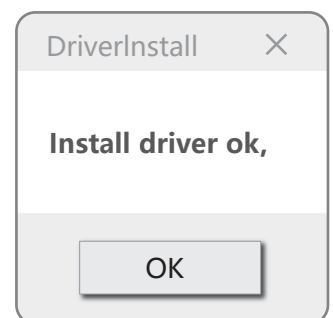
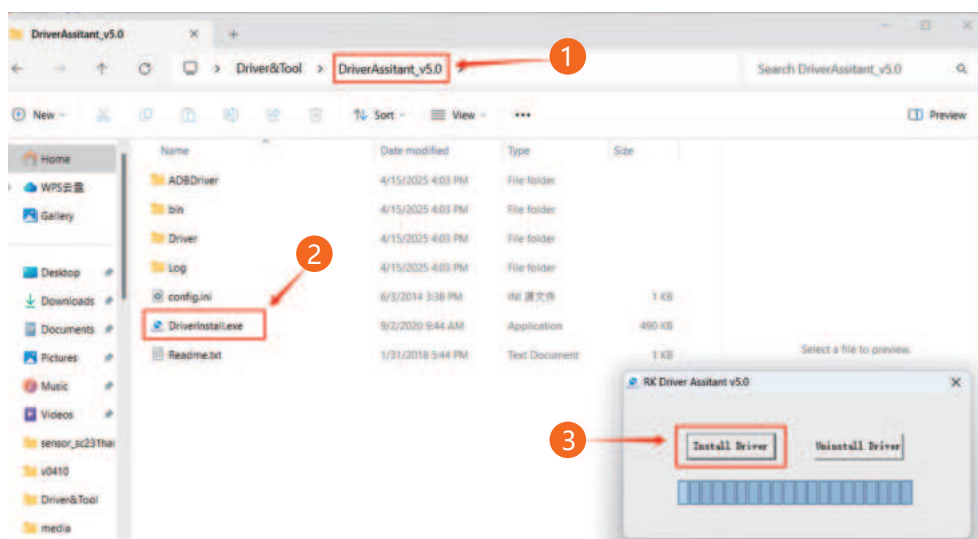

D. Flashing System Image File

1. Open the RKDevTool_Release_v2.96 folder and locate the RKDevTool.exe file. Double-click to execute it.

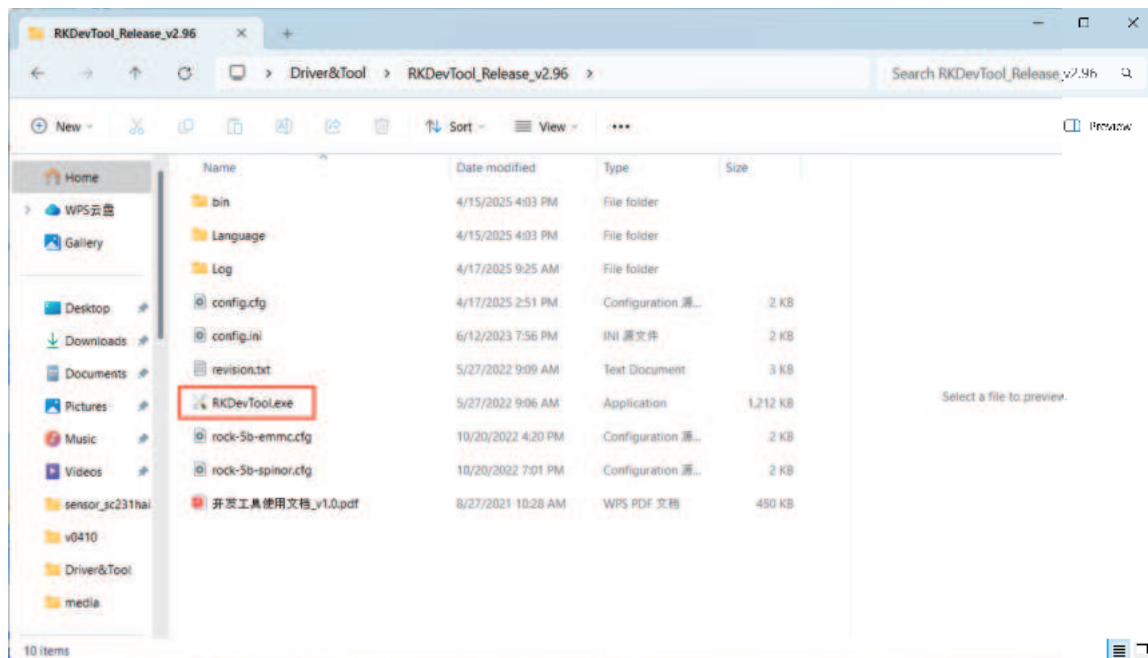

2. Since the WiFiLink-RX is not yet connected to the computer, the RKDevTool flashing tool will display "No devices found" in the lower-left corner.

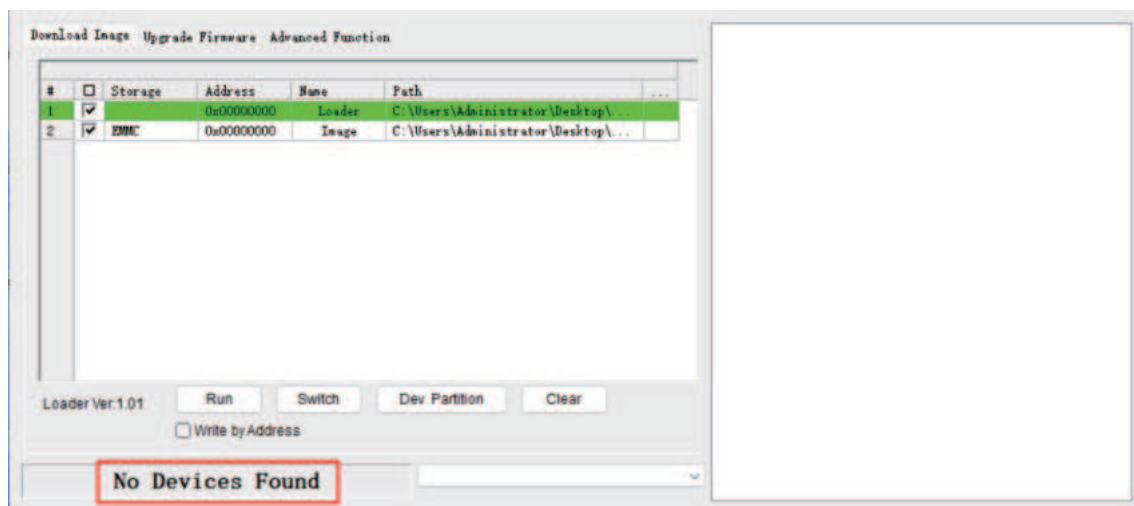

3. Make sure the WiFiLink-RX is properly connected to the antenna, and that the TF card is removed (to prevent data loss).

4. Use a SIM eject tool or a small screwdriver to press and hold the flash button, then connect DC power. Wait for 2 seconds, then release the button.



5. Connect the WiFiLink-RX to the computer via Type-C data cable.

6.If the previous steps were completed correctly, the WiFiLink-RX will enter flashing mode. The flashing tool will display “One MASKROM device found” on the interface.

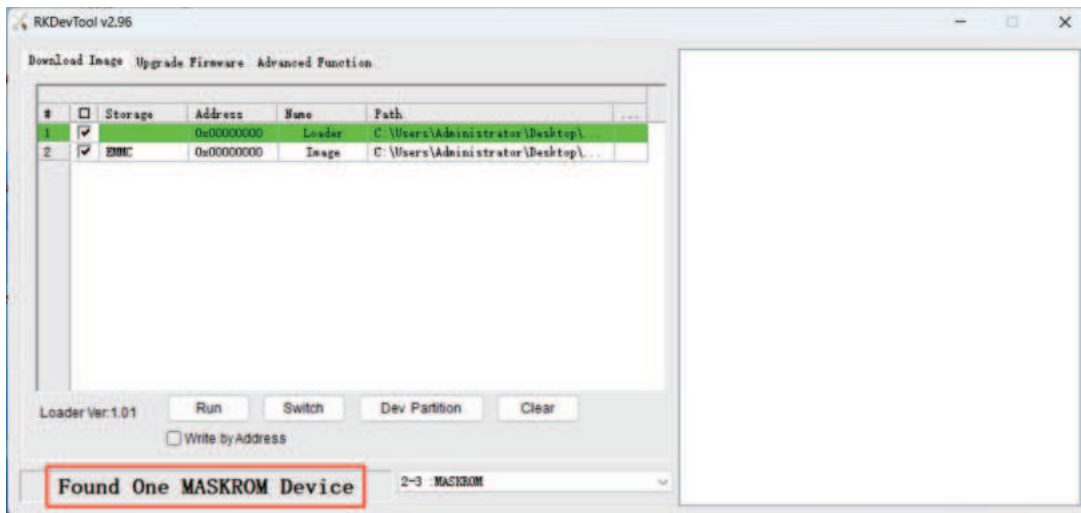

7. When RX enters a flashing mode (MASKROM available), the paths for Loader and Image need to be changed. Click the area shown in the image below to select the “Loader” file.

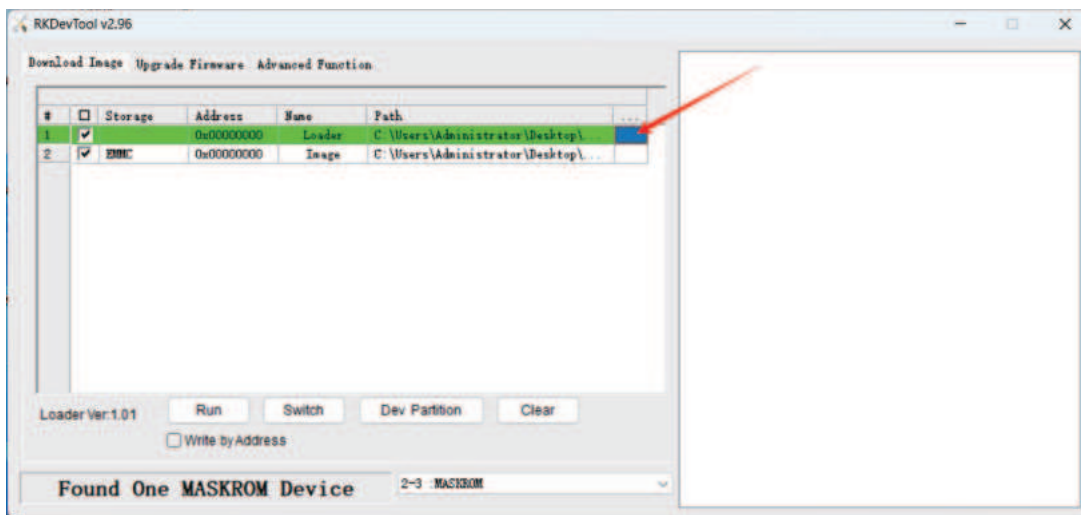

8. Locate Drive&Tool folder and select rk356x_spl_loader_ddr1056_v1.10.111.bin to open.

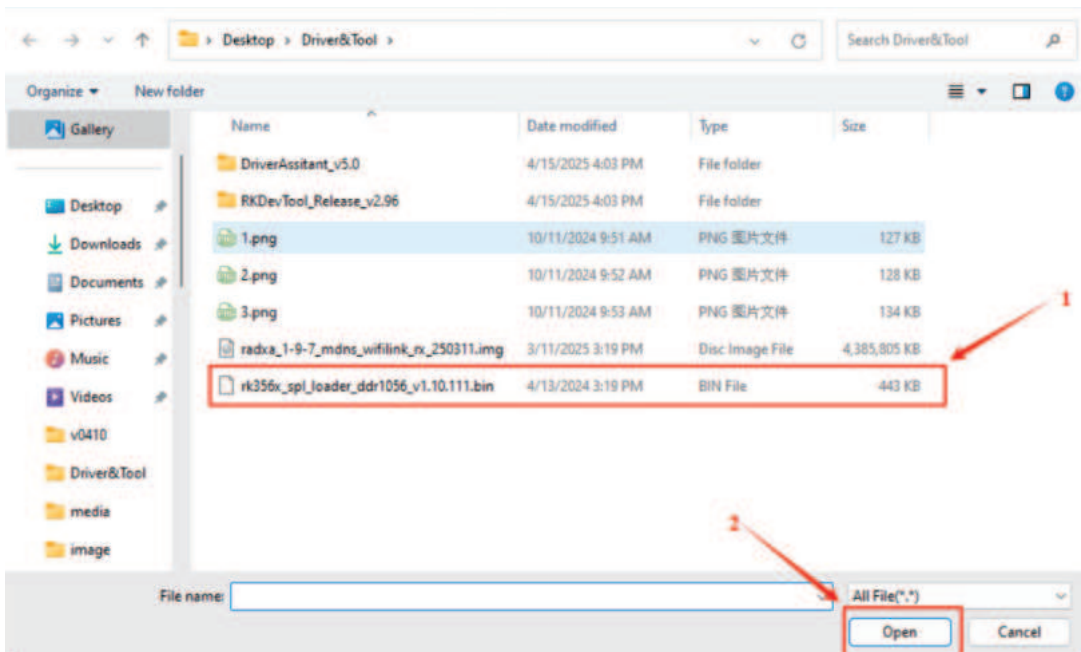

9. Click the area for Image as well.

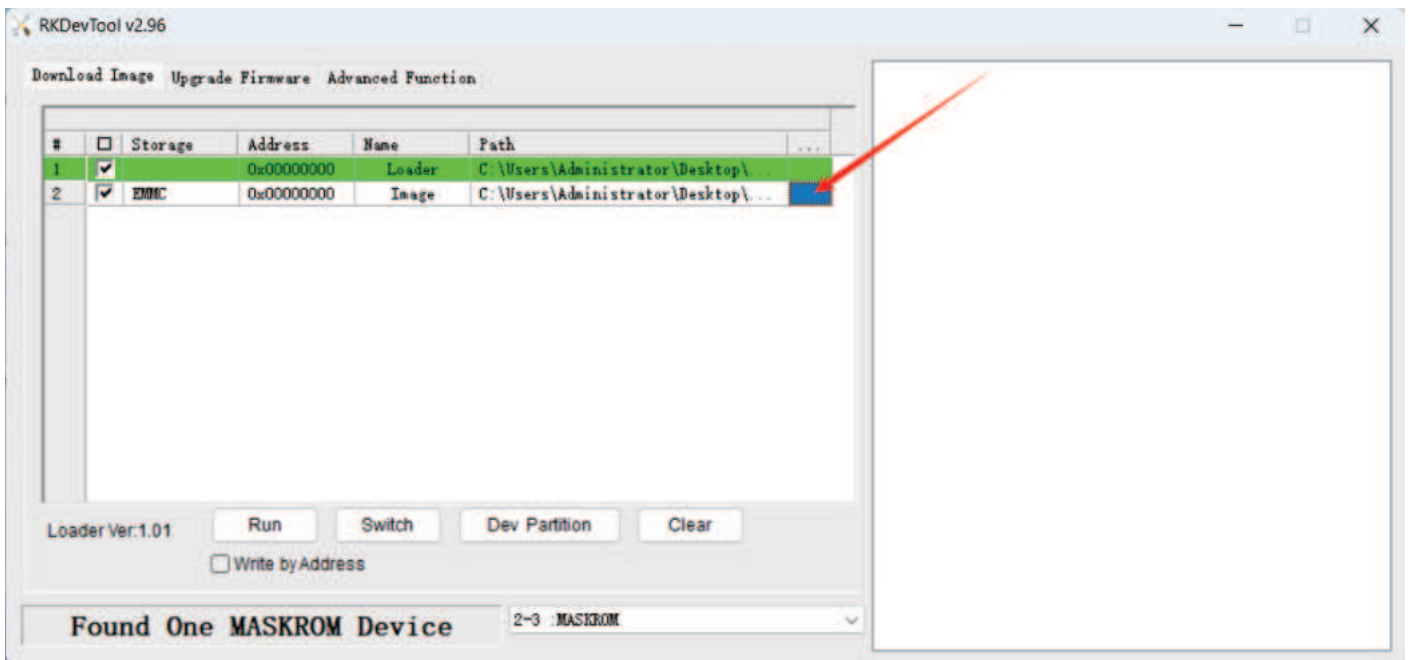

10. Select the system image file to be flashed, then click “Open.” (In this example, version 1.9.8 is used.)

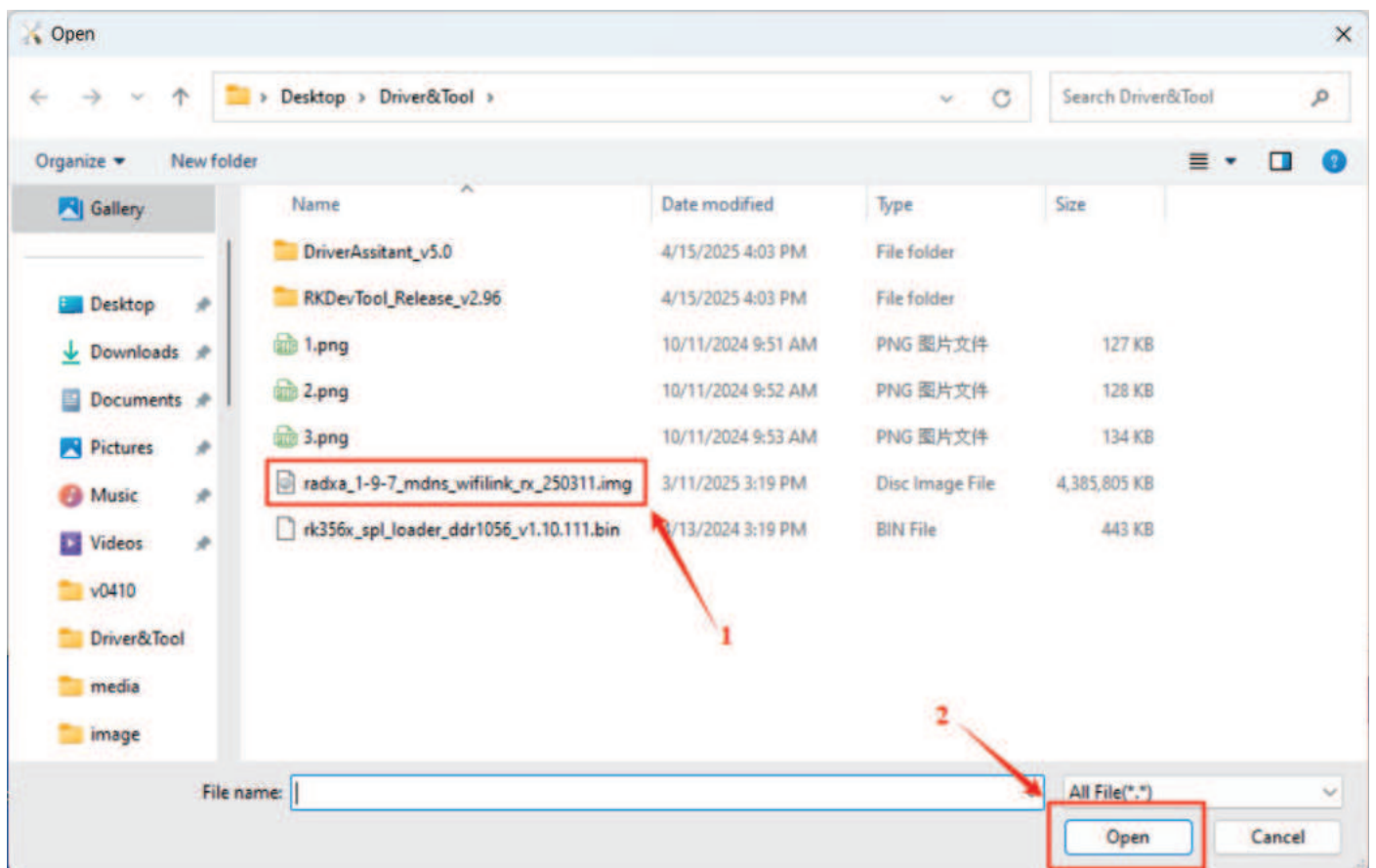

11. After selecting the paths for both Loader and Image, please must tick Write by address.

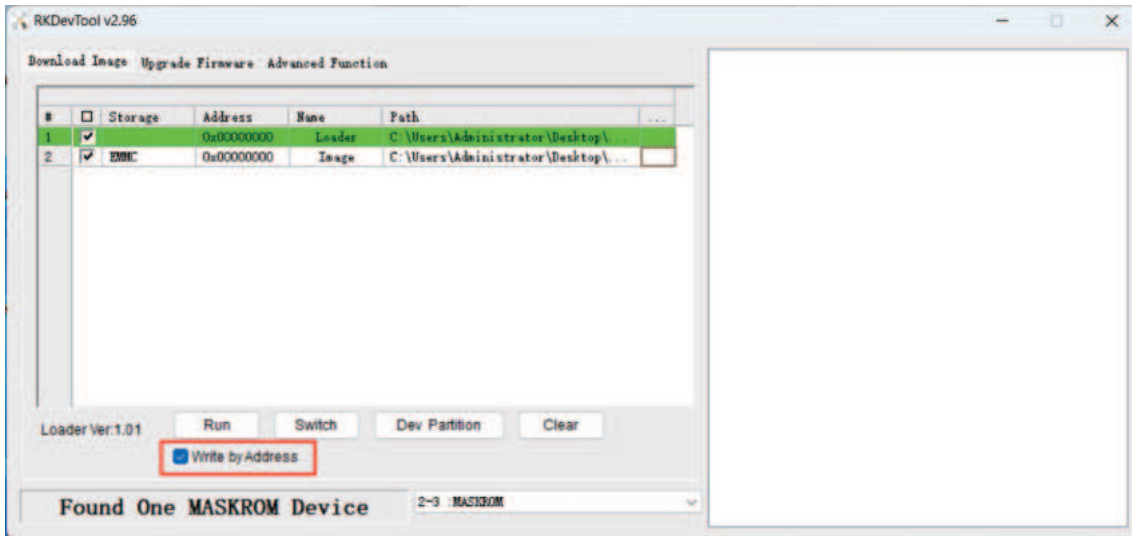

12. Click to execute, and the tool will start flashing the firmware for WiFiLink RX.

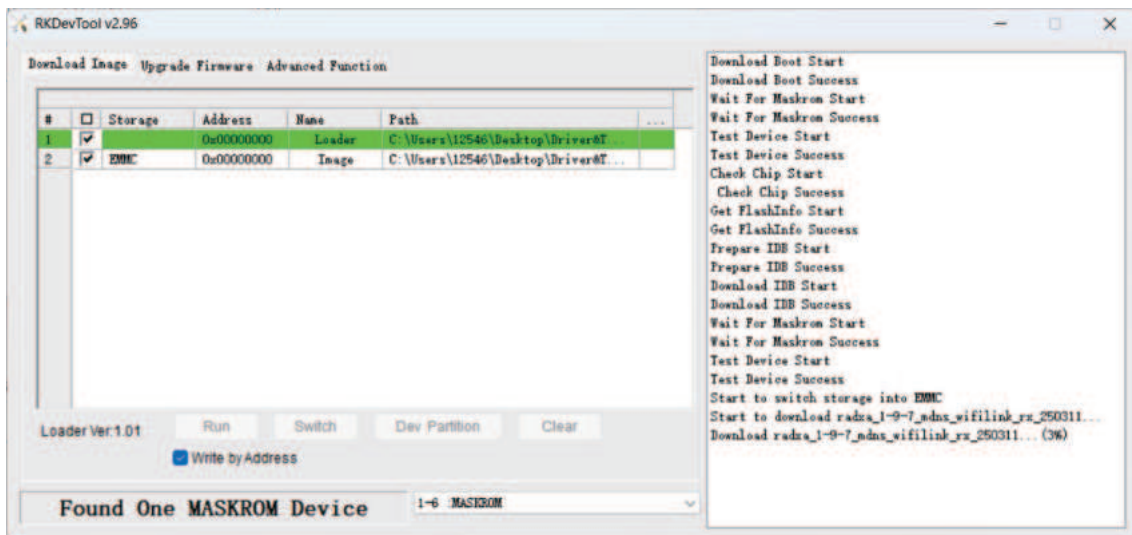

13. It takes about two minutes to finish flashing.

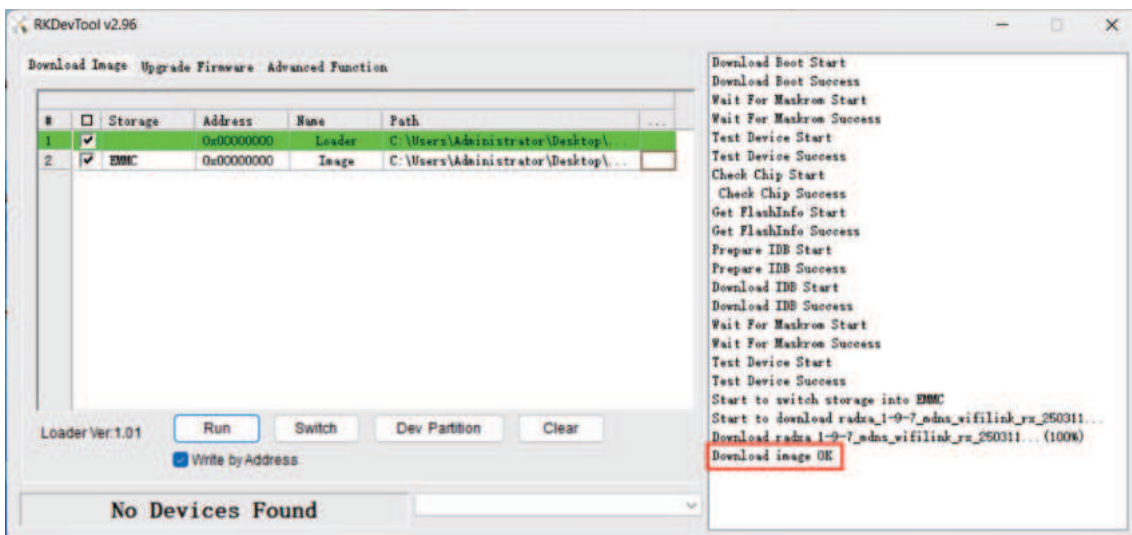

A. Adjusting WiFiLink-RX Frequency and Air Unit Power

1. Press down on the 5-Way Button to open the menu, then select Quick Vehicle Setup to enter the quick setup menu.

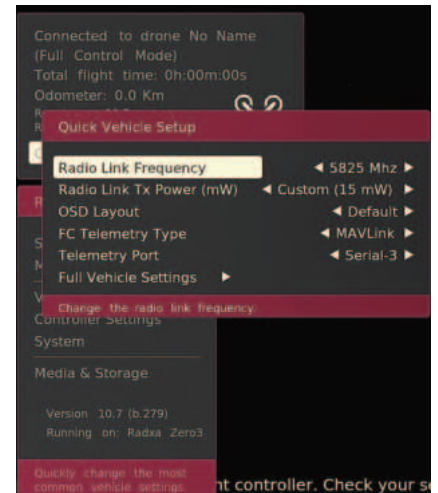

2. Select Radio Link Frequency to adjust the frequency channel.

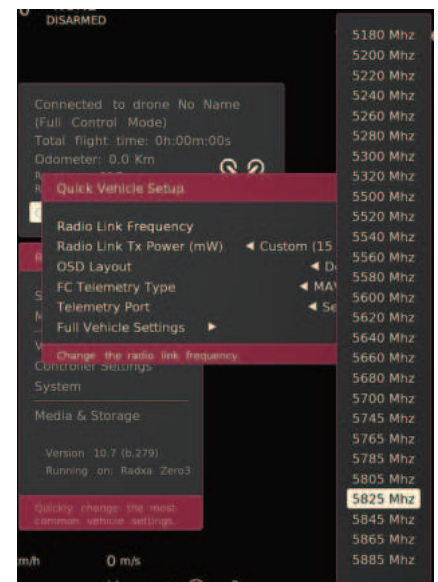

3. Select Radio Link Tx Power to adjust the air unit's transmission power.

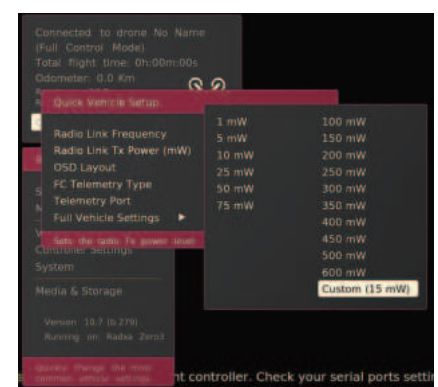

4. Select FC Telemetry Type to change the telemetry protocol (default is MAVLink).

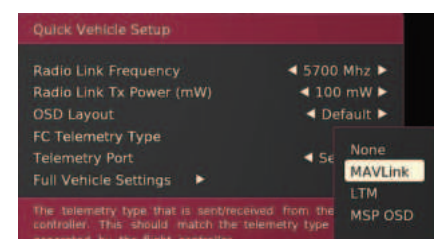

B. Adjusting Air Unit Video Output via WiFiLink-RX

1.Press down on the 5-Way Button to open the menu bar, then select Vehicles Settings → Video to enter the video settings.

2.Select Video Profile to adjust the video quality. The default is High Quality. High Performance can be selected to achieve lower latency.

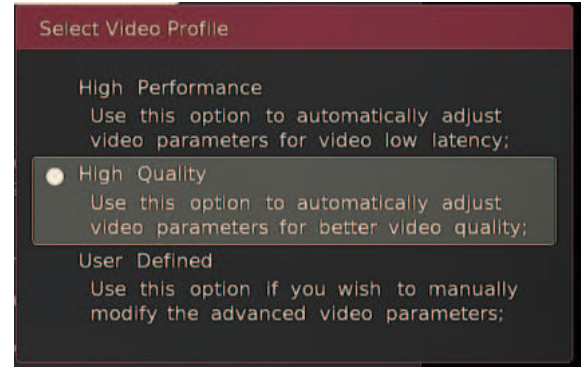

3.Select Video Codec to adjust the video format. (The default H.264 is recommended.)

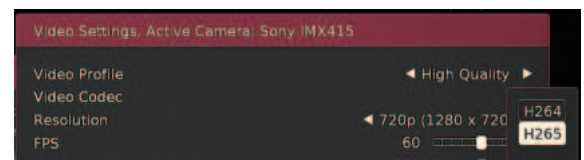

4. Select Resolution to adjust the video resolution. (Note: Resolutions exceeding 1080P will significantly affect the frame rate and may cause system lag. It is not recommended to exceed 1080P for general use, unless necessary.)

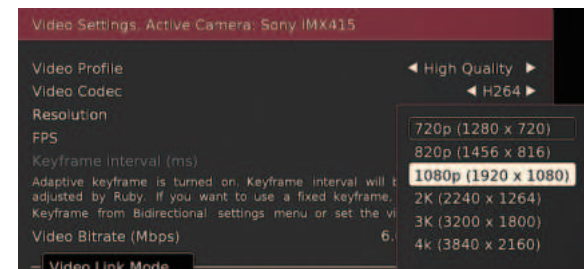

5.Select FPS to adjust the video frame rate. (The maximum frame rate varies depending on the resolution setting.)



6.Select Video Bitrate to adjust the video bitrate. (The default 6 Mbps is sufficient for most scenarios.)



C. Setting HDMI Video Output on WiFiLink-RX

1. Press down on the 5-Way Button to open the menu bar, then select Controller Settings → Audio & Video Output to enter the settings.

2. Select HDMI Output Resolution to adjust the output resolution.

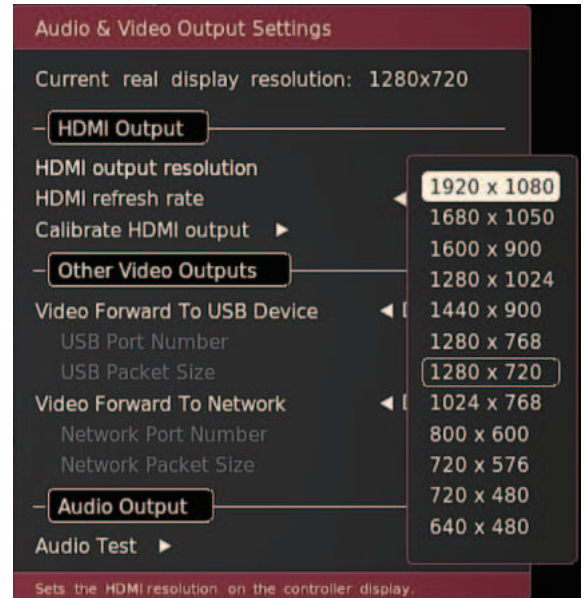

3. Select HDMI Refresh Rate to adjust the output frame rate.



D. Exporting Internal Storage Video from WiFiLink-RX

1. Power on the WiFiLink-RX with the antenna properly connected. After the device starts up, insert a USB drive into the OTG port on the WiFiLink-RX.



2. Press down on the 5-Way Button to open the menu, then select Media & Storage → Move media files to USB memory stick. After pressing Confirm, the video files from the internal storage will be moved one by one to the root directory of the USB drive.



3. Export completed interface.

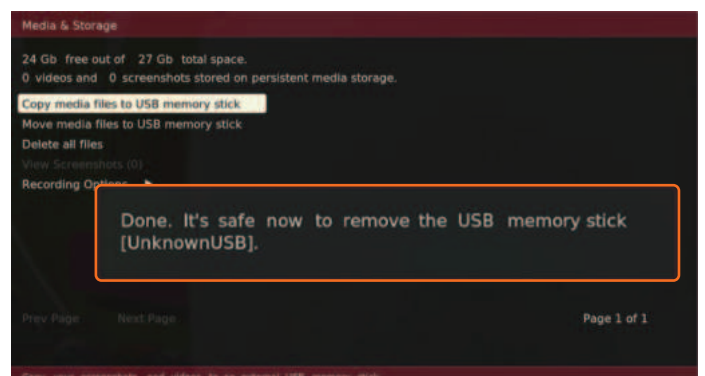

1. Before powering on, please ensure all antennas are properly installed to avoid damage to components.
2. Please confirm that the display supports the set resolution and frame rate; otherwise, it may cause display issues.
3. If using with other 5.8G devices, please select a different frequency channel.
4. If you experience choppy video, it may be due to interference from other 5.8G devices. Try switching to a different frequency channel to resolve this issue.
5. Before using this product, please ensure you fully understand and comply with local laws and regulations.