



# **WiFiLink-RX**

User Manual-OpenIPC System v1.1

# Catalogue

<b>I.Product Overview</b>	01
<b>II.Firmware Support</b>	02
<b>III. Specifications</b>	03
<b>IV. LED Status Indicators</b>	04
<b>V. Button Functions</b>	05
5-way Button	05
Record Button	05
Flash Button	05
<b>VI. Connecting to Air Unit</b>	06
<b>VII. System Flashing</b>	07
A. Obtaining the System Image file	07
B. Flashing Software	08
C. Installing Driver	09
D. Flashing the Image File	09
<b>VIII. Frequently Asked Questions</b>	13
WiFiLink-RX: Exporting Videos from Internal Storage	14
<b>IX. Notes and Precautions</b>	15

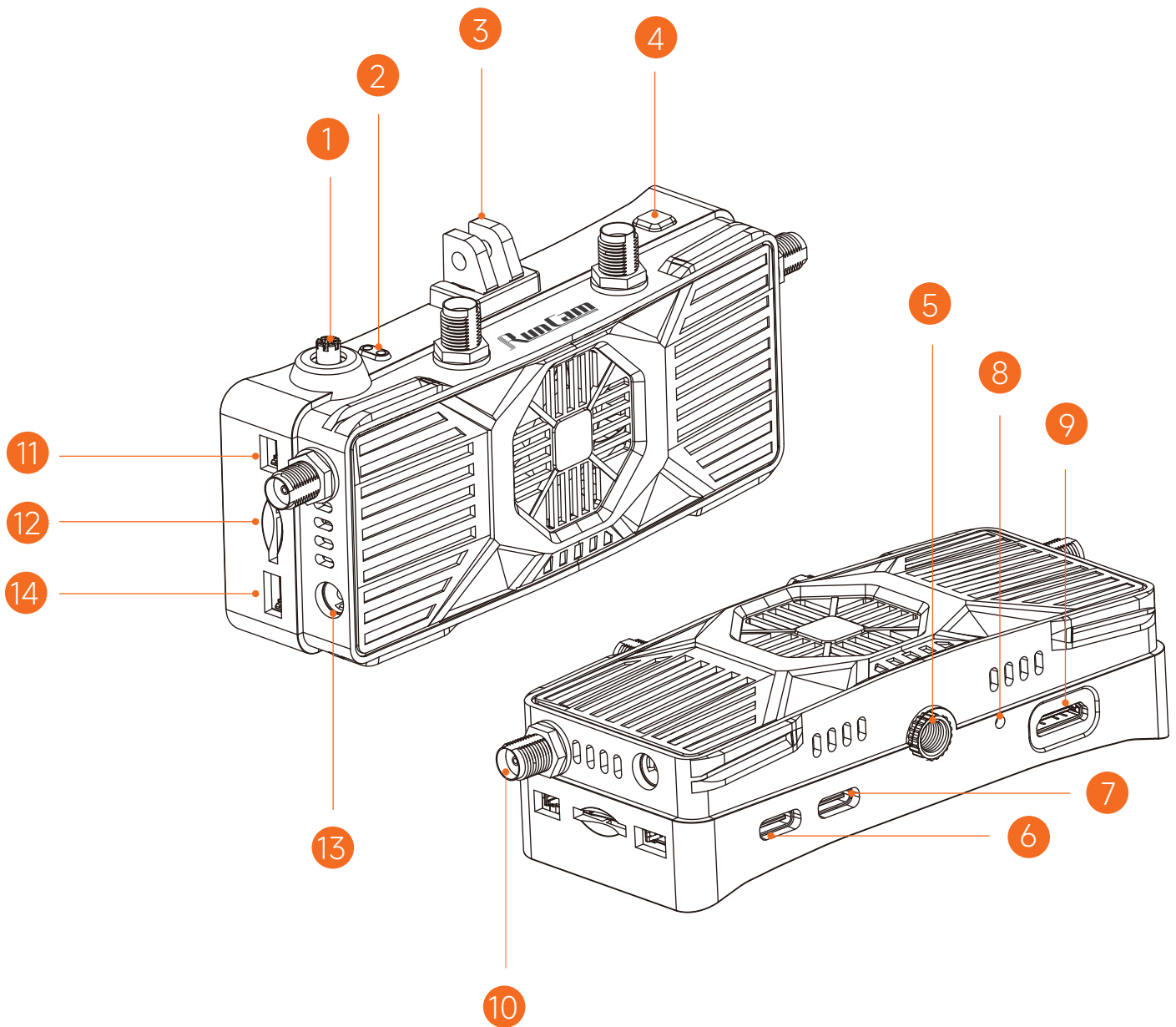

1. 5-way button

2. LED

3. Detachable mount

4. Record button

5. 1/4" threaded hole

6. OTG

7. Type-C

8. Flash button<sup>[1]</sup>

9. Mini-HDMI

10. SMA(inner pin)

11. UART expansion

12. Micro-SD slot

13. DC power input<sup>[2]</sup>

14. I2C expansion

[1]: Use a tool like SIM ejector pin or screwdriver to press.

[2]: Input power range: 9V ~ 30V.

Supports Ruby FPV or OpenIPC system. The default factory firmware is OpenIPC.

### OpenIPC Interface Overview



### Ruby FPV Interface Overview



Model	WiFiLink-RX
Frequencies	5GHz
Transmission Power	<25dBm(FCC) <14dBm(CE) <20dBm(SRRC) <25dBm(MIC)
Interface	Mini-HDMI, Micro-SD, DC 5.5×2.1mm,Type-C
Mini-HDMI Output	1080P 60fps / 720P 60fps
Power Input	9~30V (3~6S)
MicroSD Card	Supports up to 256GB
Memory and Storage	1GB RAM + 32GB eMMC
System	Ruby FPV / OpenIPC
Dimensions	(L)110.0mm×(W)27.3mm×(H)46.0mm
Weight	122.0g (±1g) (antenna excluded)

Model	Stick Antennas
Polarization	Vertical Polarization (VP)
Frequencies	5150~5850 MHz
Average Gain	2.5dBi
Standing Wave Ratio (SWR)	≤2.0
Dimensions	(R)4.8mm×(H)108.4mm
Weight	6.6g

Model	Pagoda Antennas
Polarization	Left-Hand Circular Polarization (LHCP)
Frequencies	5500~5900 MHz
Average Gain	2.5dBi
Standing Wave Ratio (SWR)	<=2.0
Dimensions	(R)8.0mm×(H)23.9mm
Weight	4.4g

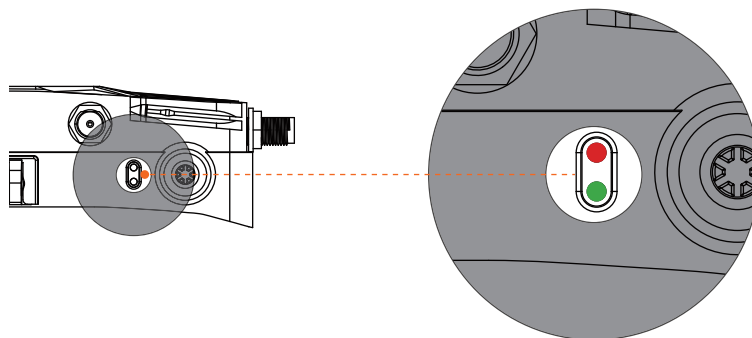

**Green LED solid on:** Wi-Fi is functioning normally

**Green LED off:** Wi-Fi malfunction

**Red LED solid on:** RX is powered

**Red LED slow blinking:** Recording in progress

**Red LED fast blinking:** Storage is full

**Red and green LEDs blinking alternately:** High temperature warning

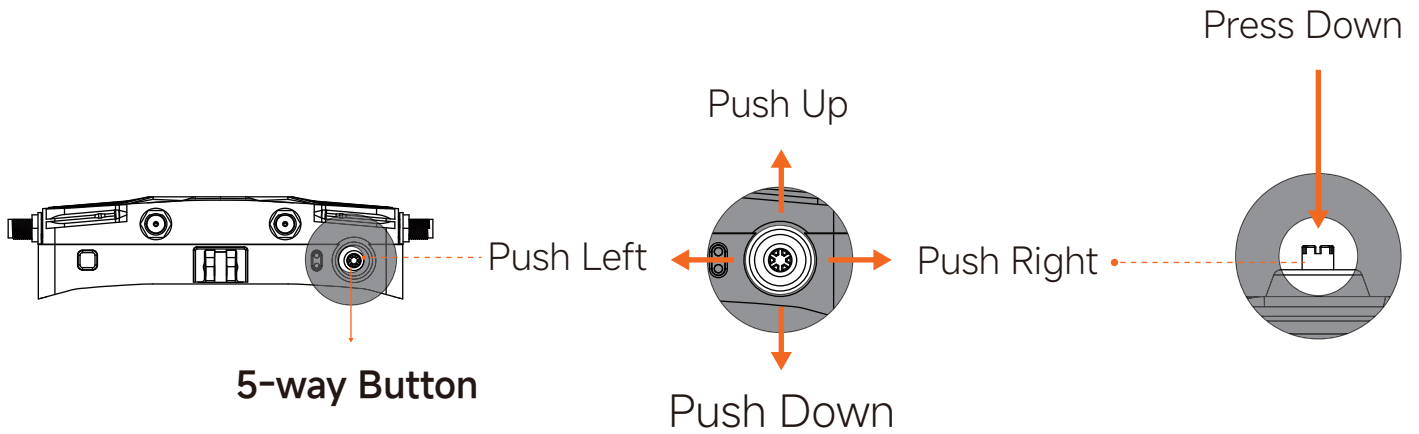

**Ruby System:** Push right to switch OSD interface. Press Down to confirm or open menu. Push up or down to navigate, and Push left to return to the previous menu.

**OpenIPC System:** Push up or down to change frequencies. Push right to adjust bandwidth (20MHz / 40MHz).

(Note: The above button functions are based on Ruby FPV V10.7 / OpenIPC V1.9.8. Button behavior may differ in future firmware versions. Please refer to the actual system for the most accurate information.)

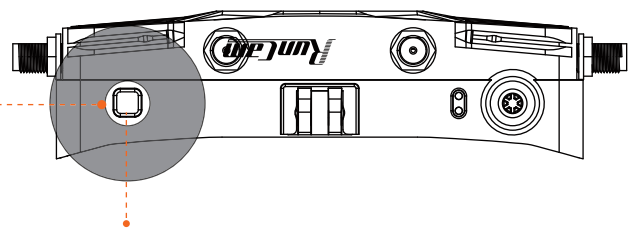
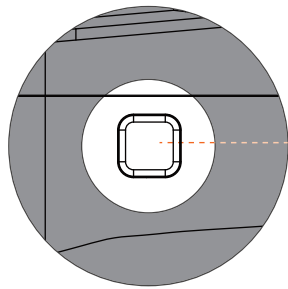

**Record Button**

Press to start or pause recording.

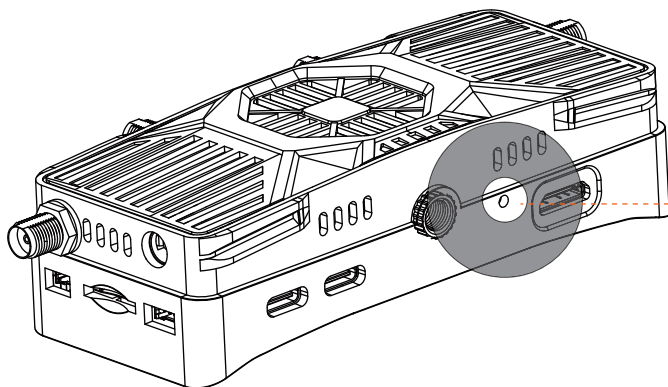

**Flash Button**

Press and hold the flash button, then connect DC power. After 2 seconds, release the button — the RX will enter flashing mode. At this point, connect the RX to a computer via Type-C, and begin the flashing process...



Demo Video URL

1. Install antennas for both WiFiLink 2 and WiFiLink-RX, then power both devices. Connect WiFiLink-RX to a display via HDMI cable.



2. Once the device has booted up, push the 5-Way Button to the right to set the bandwidth to 20MHz, then push up/down to adjust the frequency to 5805MHz (this is the default frequency).



3. Wait about 10 seconds. Once the connection is established, the video feed will be displayed.





Note: Flashing the system will erase all files on the WiFiLink-RX's internal storage (eMMC) and TF card. Please back up important data in advance.

## A. Obtaining the System Image file

1. Open the link below, select the target version, and locate the image file with the .img.xz extension.

<https://github.com/OpenIPC/sbc-groundstations/releases>

▼ Assets 4		
gs.key	64 Bytes	5 days ago
radxa_1-9-8_onboard.img.xz	833 MB	4 days ago
Source code (zip)		Feb 11
Source code (tar.gz)		Feb 11

2. Extract the downloaded compressed file to obtain a system image file.

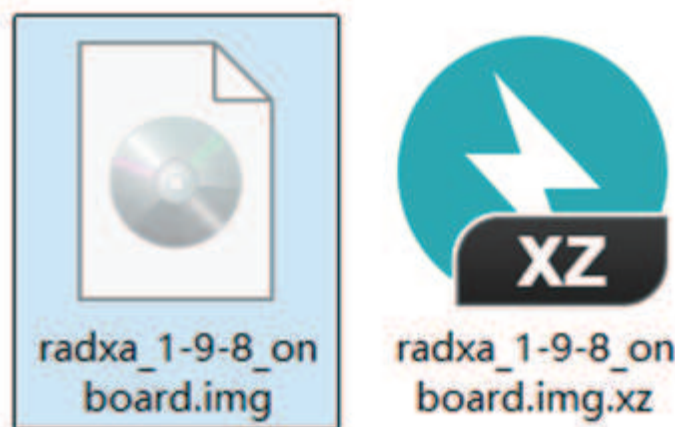

<https://flowus.cn/share/9a06aa6f-9c0a-43a8-95e8-a50953f72480?code=ADWFHZ>

## B. Flashing Software

1. Click the link below to download the compressed Driver&Tool compressed file.  
GoogleDrive:

<https://drive.google.com/drive/folders/1moljMrfbCeSgvW7LQA1RAOpFrKZshpGI?usp=sharing>

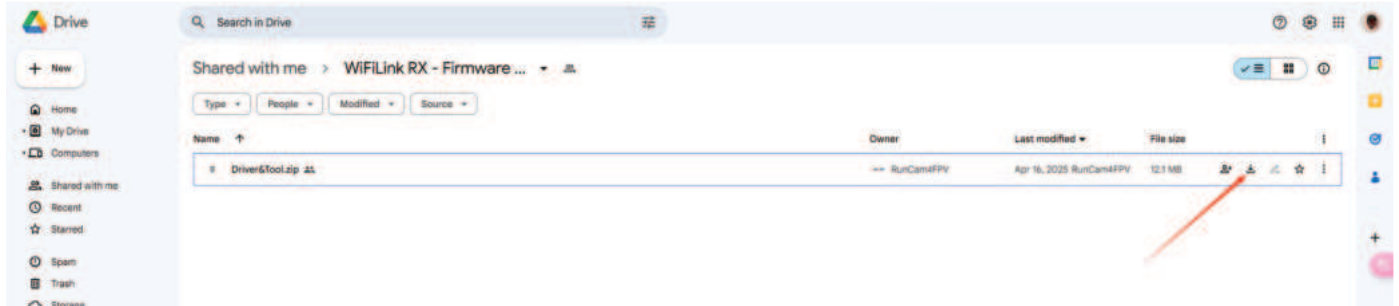

2. Extract the downloaded compressed file, to obtain flashing software and driver.

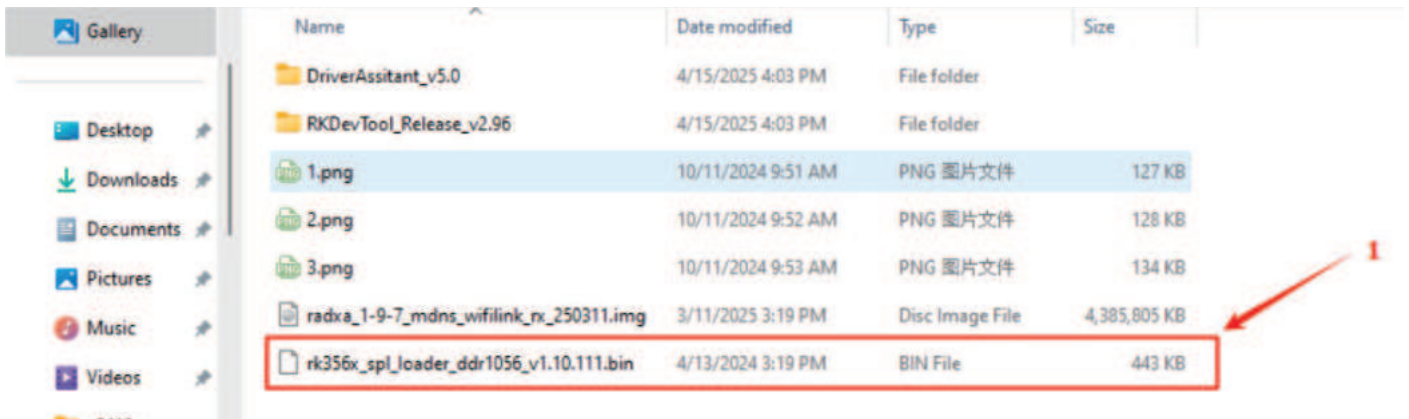

## C. Installing Driver

1. Open DriverAssistant\_v5.0 folder, find and double click DriverInstall.exe to execute it. Click Install to continue. It takes a few seconds to finish.

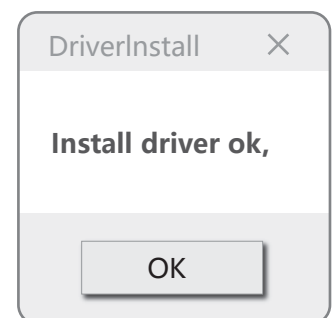
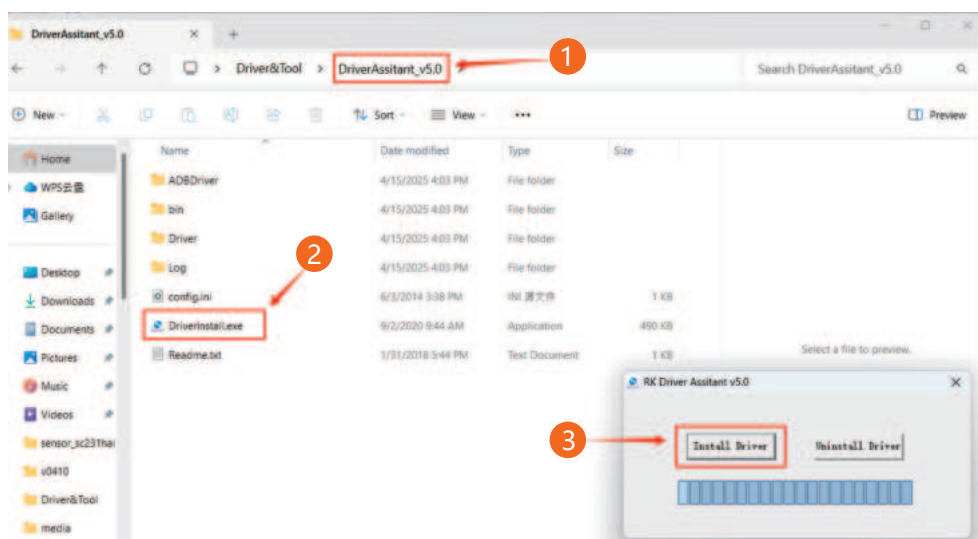

## D. Flashing System Image File

1. Open the RKDevTool\_Release\_v2.96 folder and locate the RKDevTool.exe file. Double-click to execute it.

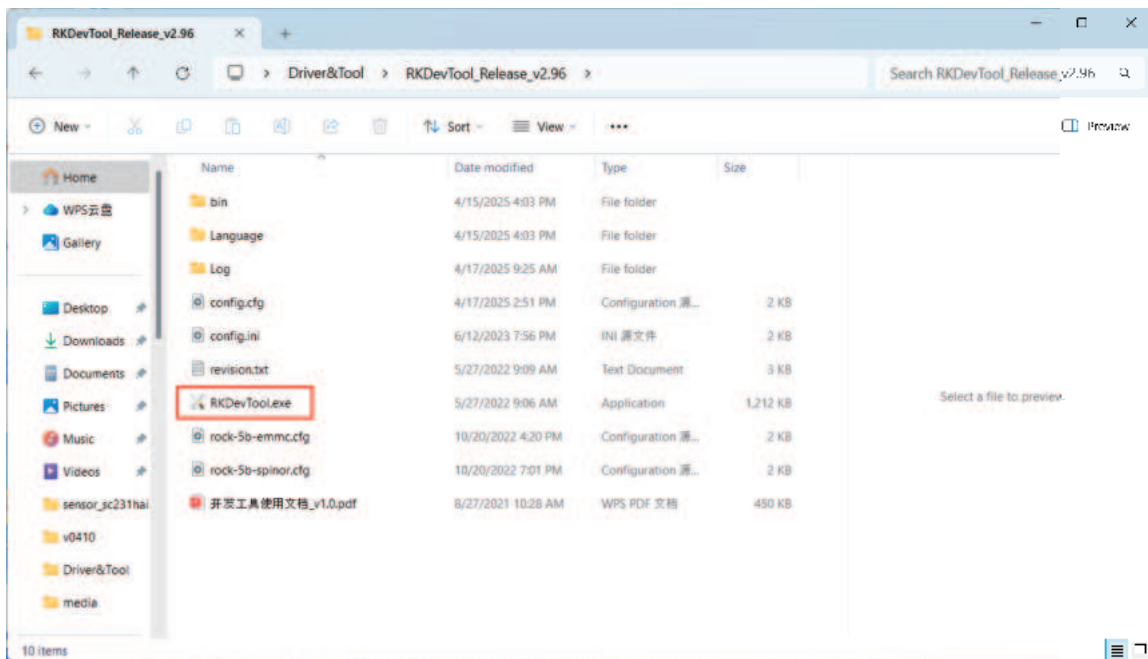

2. Since the WiFiLink-RX is not yet connected to the computer, the RKDevTool flashing tool will display “No devices found” in the lower-left corner.

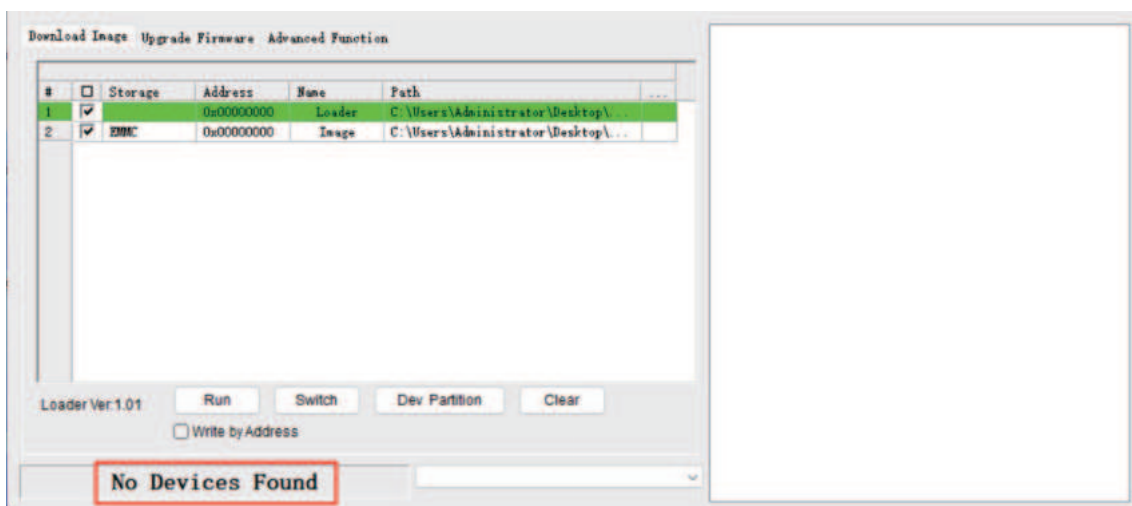

3. Make sure the WiFiLink-RX is properly connected to the antenna, and that the TF card is removed (to prevent data loss).

4. Use a SIM eject tool or a small screwdriver to press and hold the flash button, then connect DC power. Wait for 2 seconds, then release the button.



5. Connect the WiFiLink-RX to the computer via Type-C data cable.

6.If the previous steps were completed correctly, the WiFiLink-RX will enter flashing mode. The flashing tool will display “One MASKROM device found” on the interface.

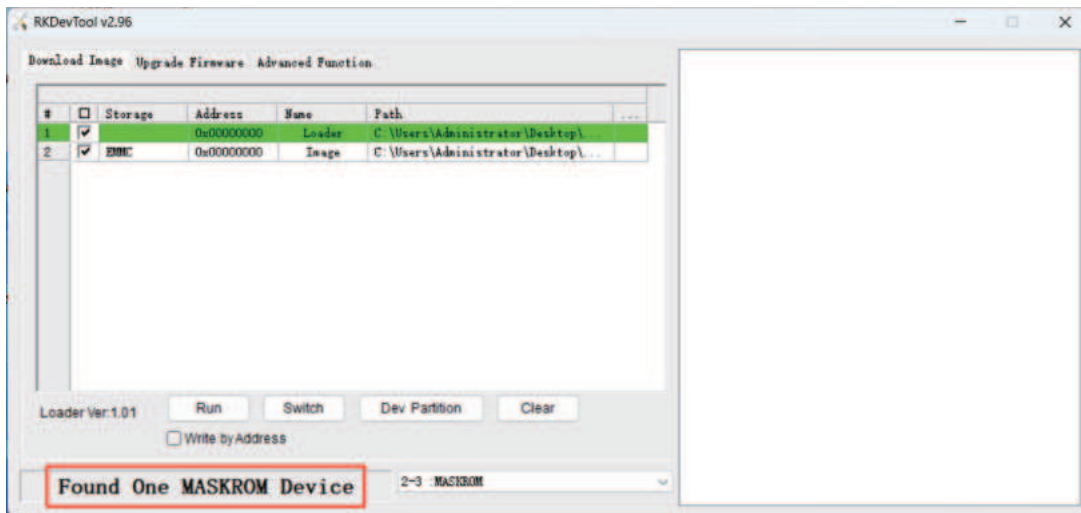

7. When RX enters a flashing mode (MASKROM available), the paths for Loader and Image need to be changed. Click the area shown in the image below to select the “Loader” file.

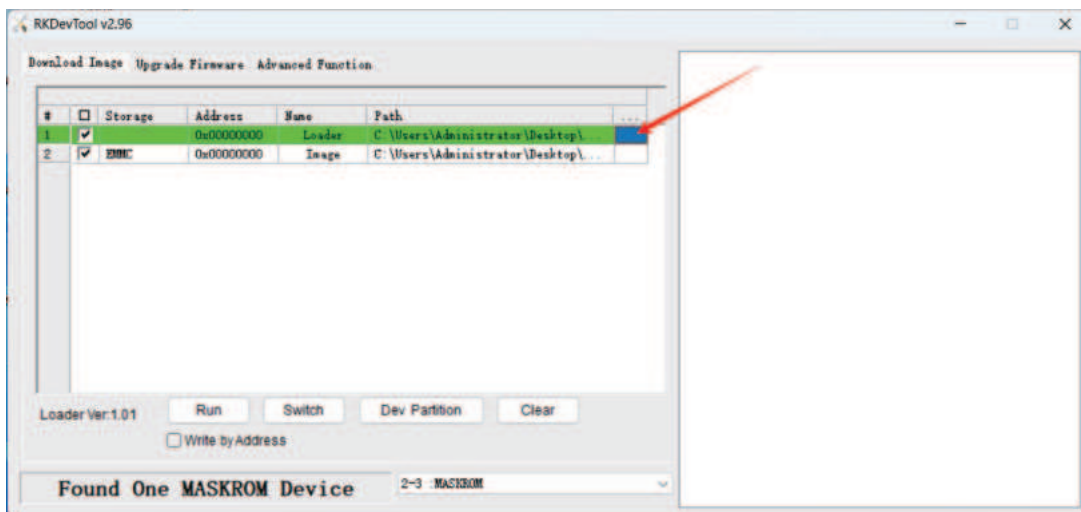

8. Locate Drive&Tool folder and select rk356x\_spl\_loader\_ddr1056\_v1.10.111.bin to open.

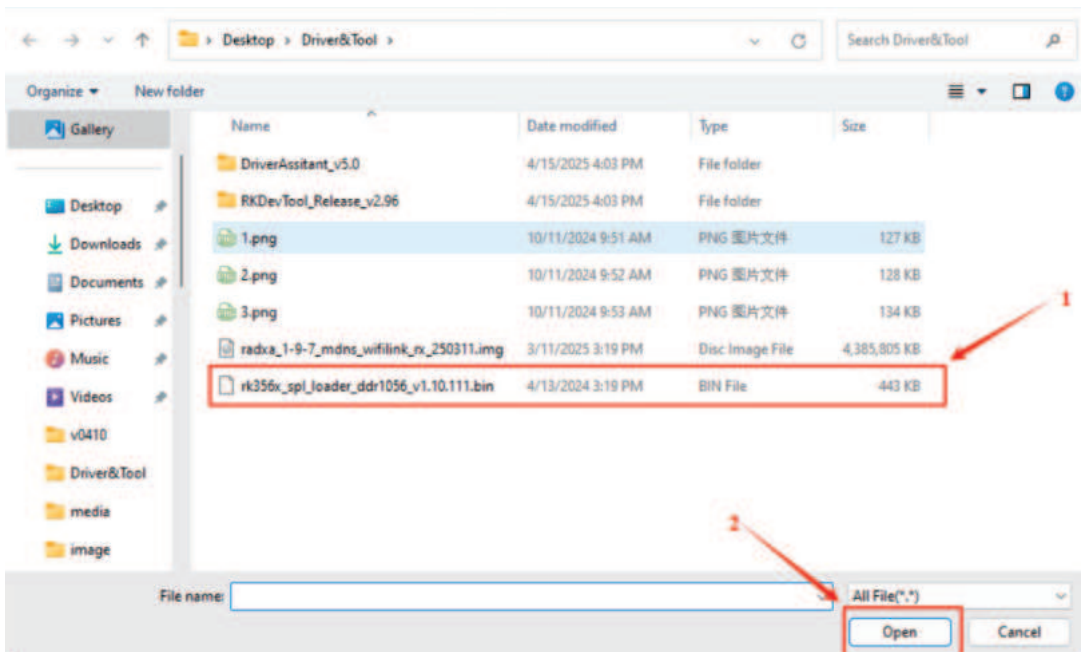

9. Click the area for Image as well.

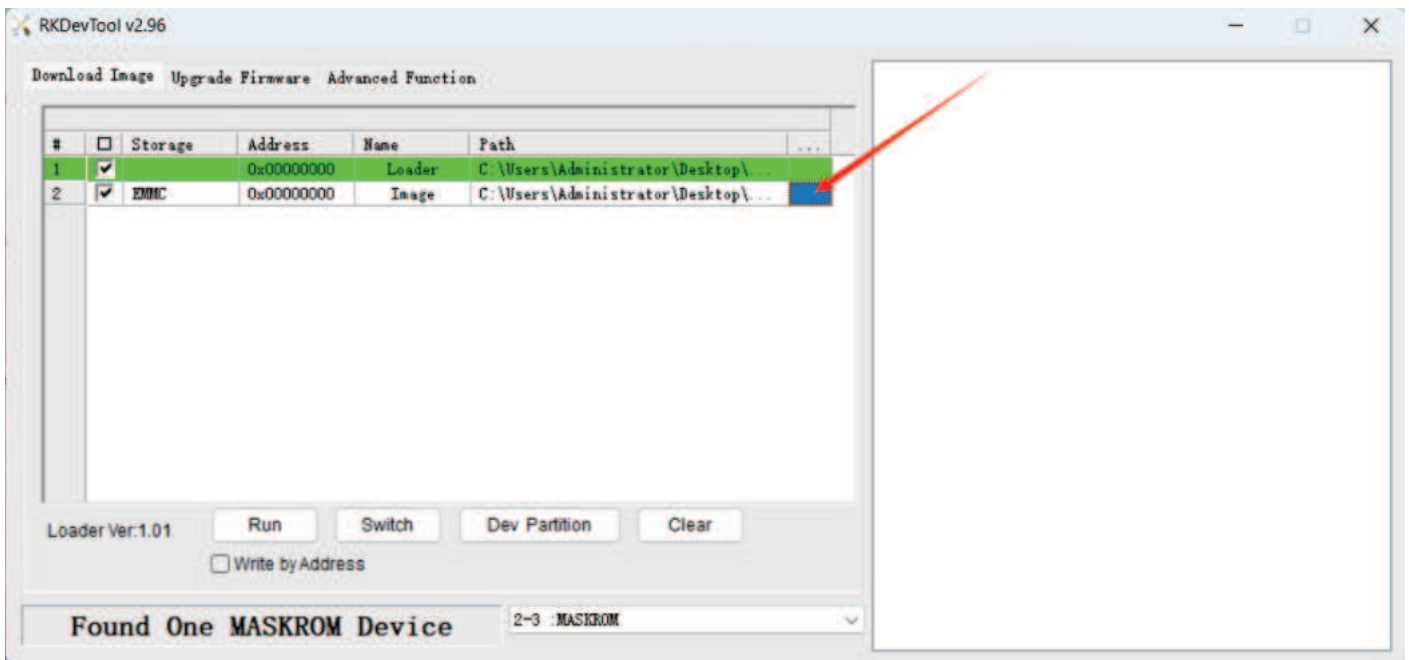

10. Select the system image file to be flashed, then click "Open." (In this example, version 1.9.8 is used.)

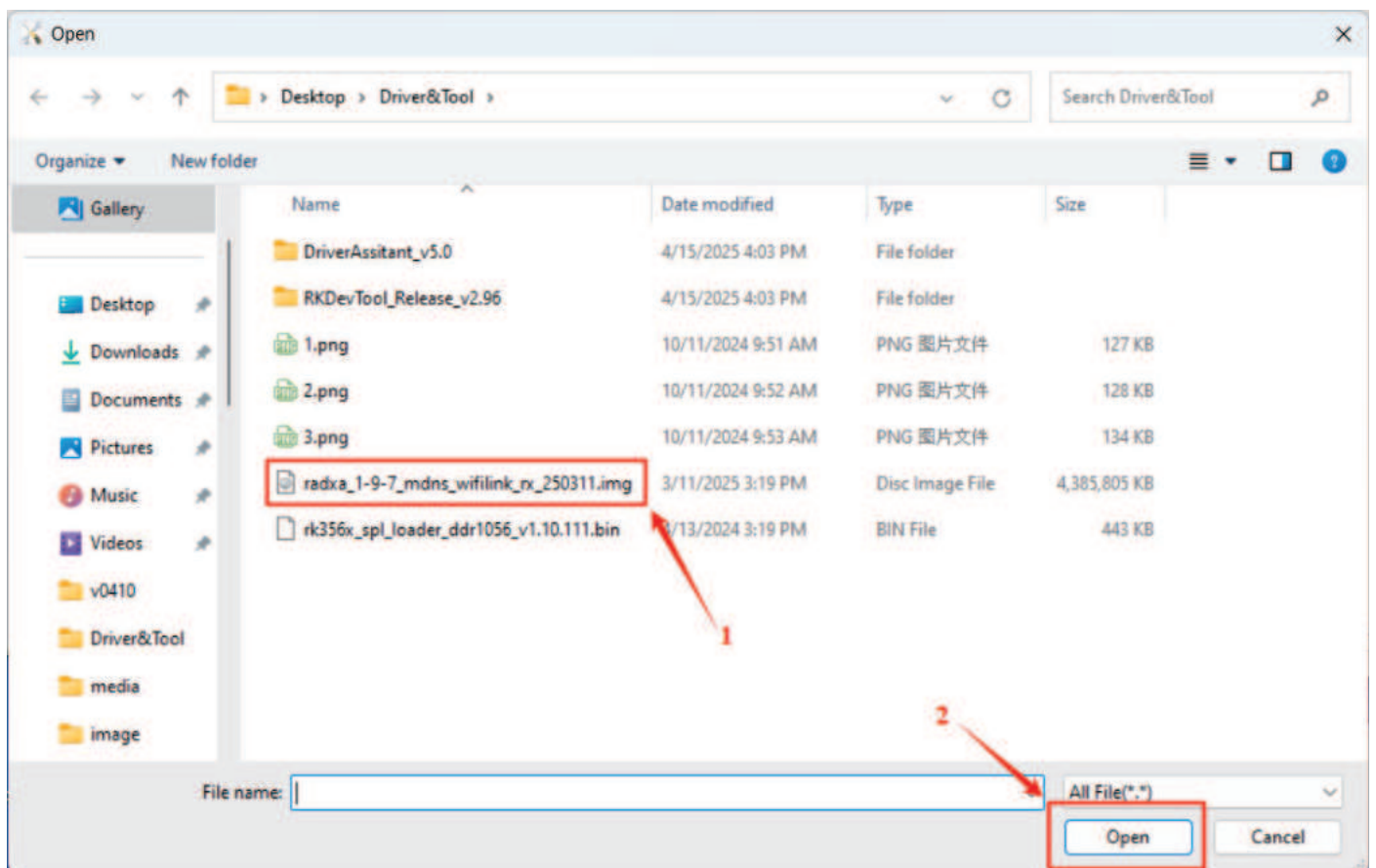



11. After selecting the paths for both Loader and Image, please must tick Write by address.

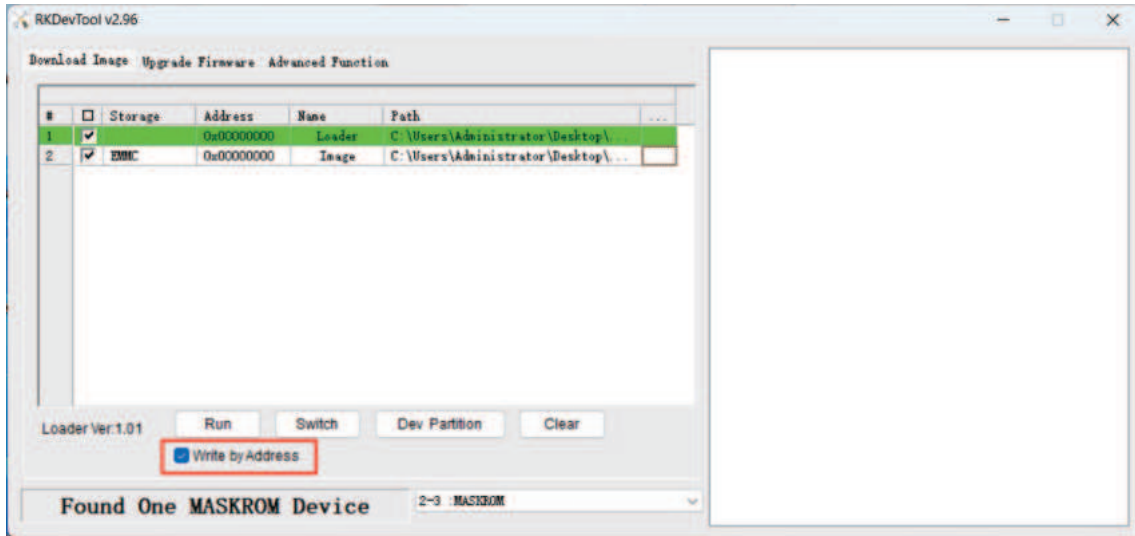

12. Click to execute, and the tool will start flashing the firmware for WiFiLink RX.

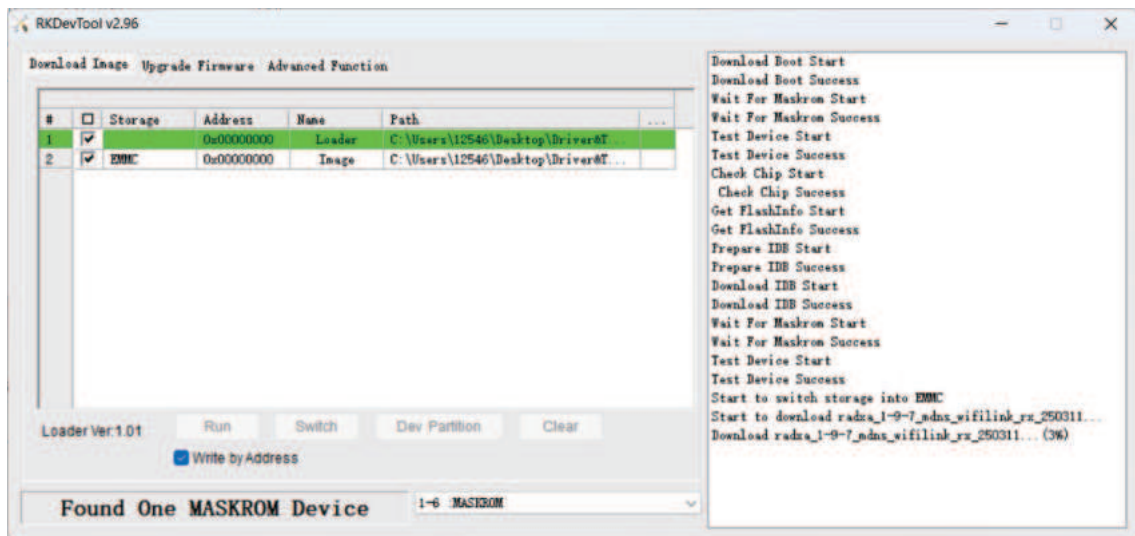

13. It takes about two minutes to finish flashing.

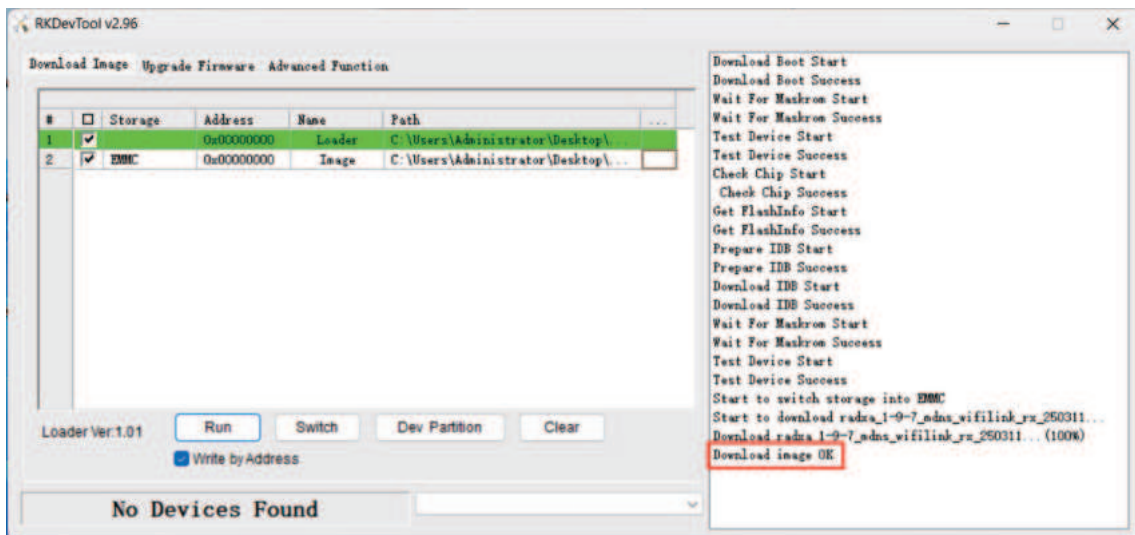



## WiFiLink-RX: Exporting Videos from Internal Storage

Note: This feature is available only on version 1.9.7 or later.

1. After installing the antennas on WiFiLink RX, power on the device. Once the system has fully booted, hold the 5-Way Button to the right for 5 seconds to enter AP Mode (hotspot mode). Connect to the Wi-Fi hotspot named “RadxaGroundstation”, with the password “radxaopenipc”.

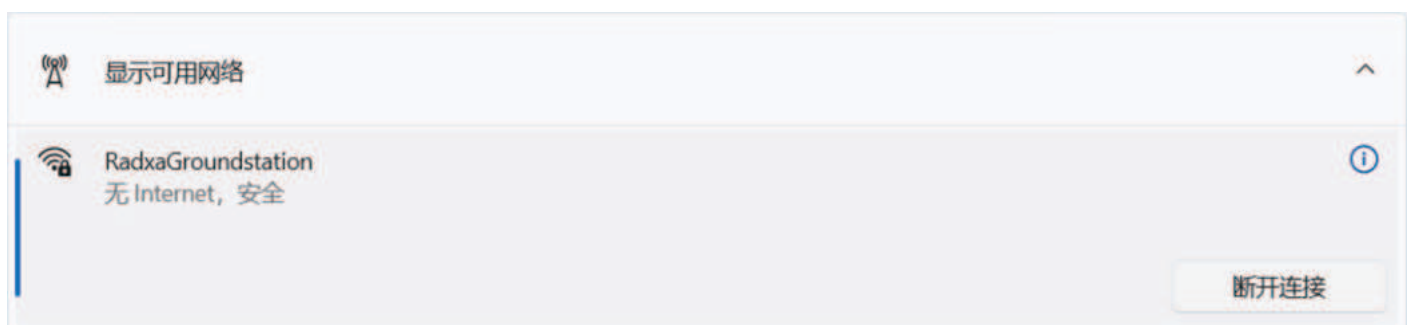

2. Open a browser and go to radxa-zero3.local to access the OpenIPC WebUI (browsing video files and adjusting ground station and camera settings are available here), click “View Video Files” to see the video list, and click “Download” to download videos. (If a TF card is inserted, files stored on the TF card will also appear here.)

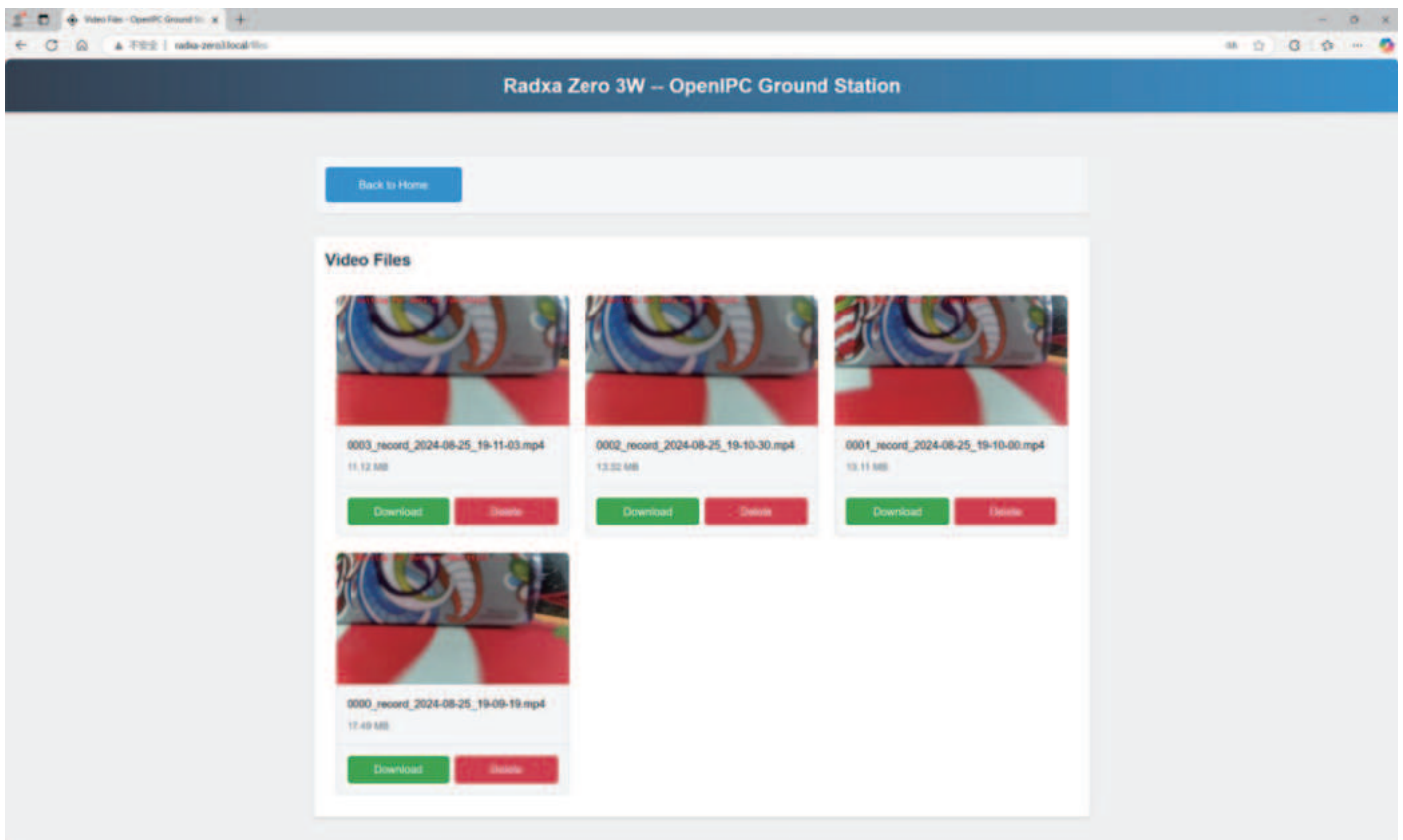
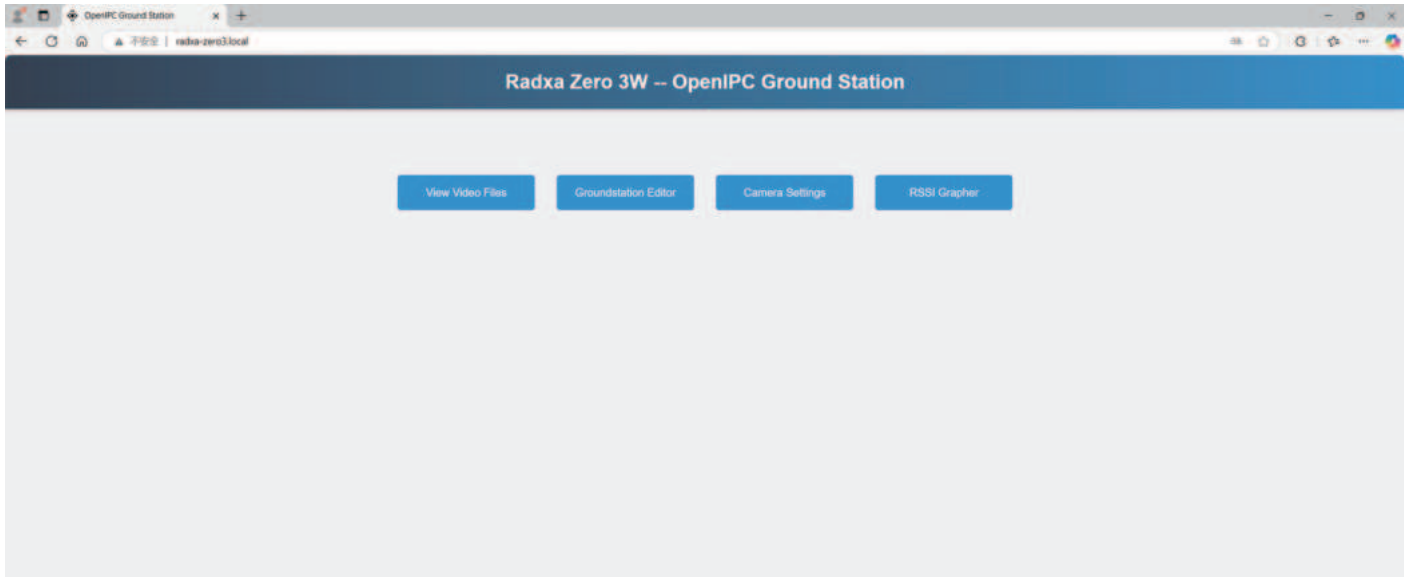

1. Before powering on, please ensure all antennas are properly installed to avoid damage to components.
2. Please confirm that the display supports the set resolution and frame rate; otherwise, it may cause display issues.
3. If using with other 5.8G devices, please select a different frequency channel.
4. If you experience choppy video, it may be due to interference from other 5.8G devices. Try switching to a different frequency channel to resolve this issue.
5. Before using this product, please ensure you fully understand and comply with local laws and regulations.